



VIDAWO

Windows | Doors | Shutters
MANUFACTURER

1/2023

Style-03 68mm „S” *STL-03-68-S*



Style 02 68mm „S”

Style 02 68mm „R”

Style 03 68mm „S”

Style 03 68mm „R”

French 01

French 02

STL-03-68-S-001

Style 02 68mm „S”

Style 02 68mm „R”

Style 03 68mm „S”

Style 03 68mm „R”

French 01

French 02

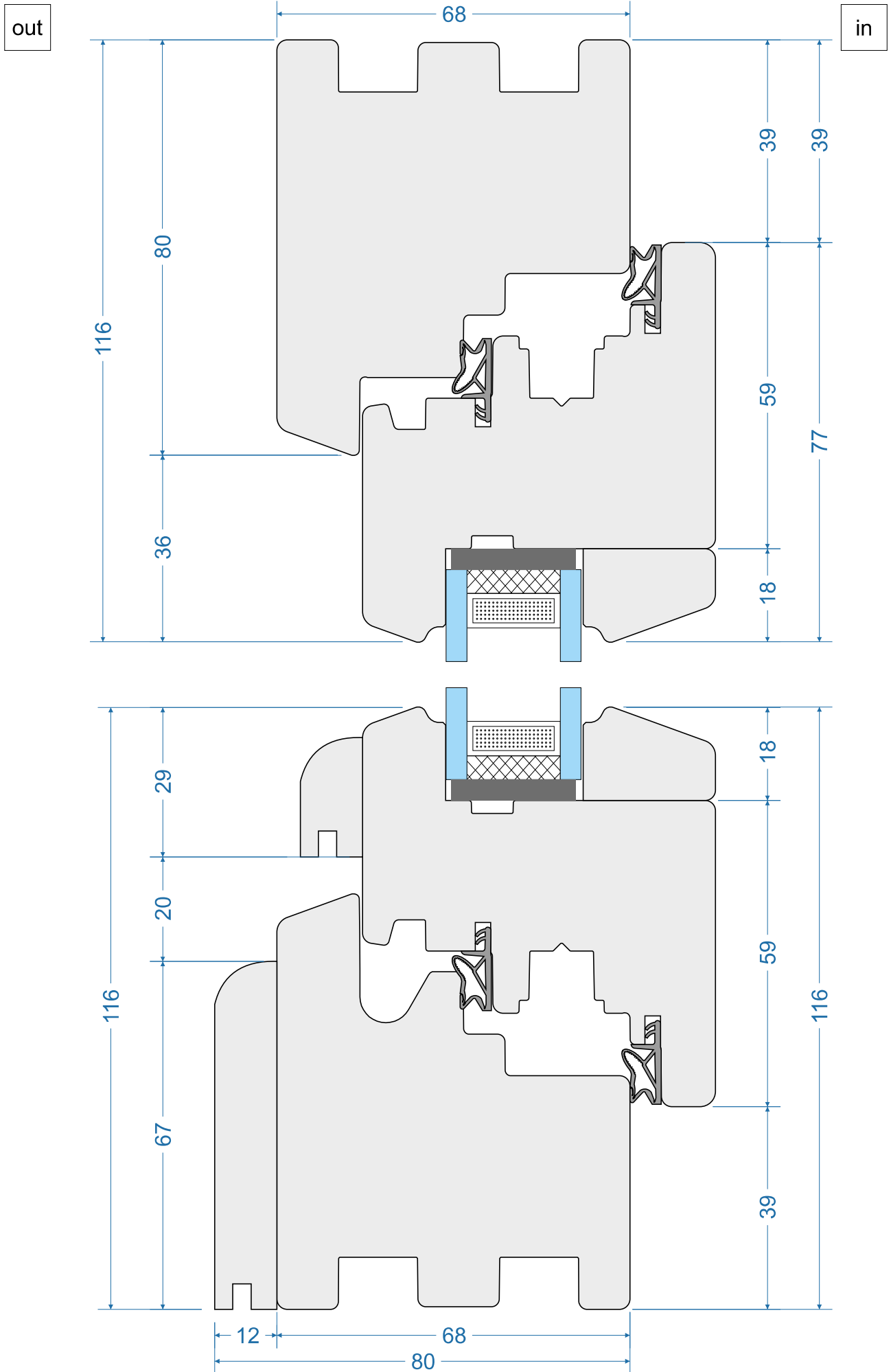



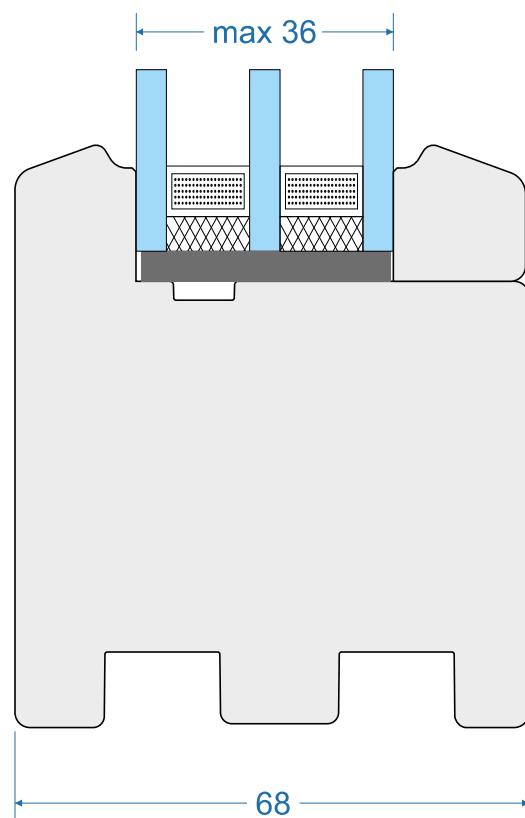
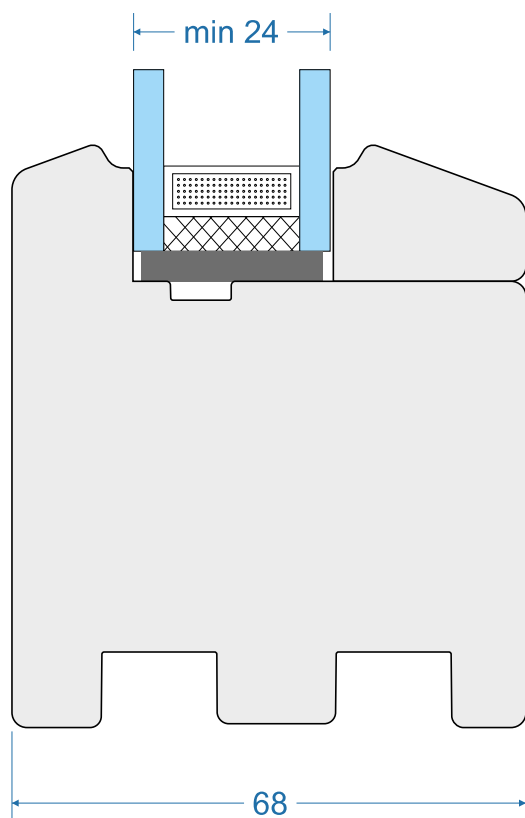

STL-03-68-S-002

out

in



-  Minimalna / maksymalna grubość pakietu szybowego
-  Minimum / maximum glass thickness
-  Épaisseur minimale / maximale du verre
-  Spessore minimo/massimo del vetro
-  Minimale / maximale Stärke des verglasungs paketes

STL-03-68-S-003

Style 02 68mm „S”

Style 02 68mm „R”

Style 03 68mm „S”

Style 03 68mm „R”

French 01

French 02

out



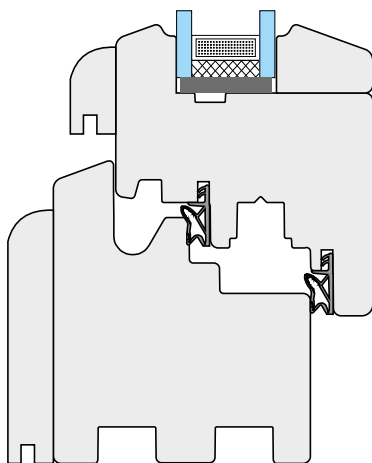

in

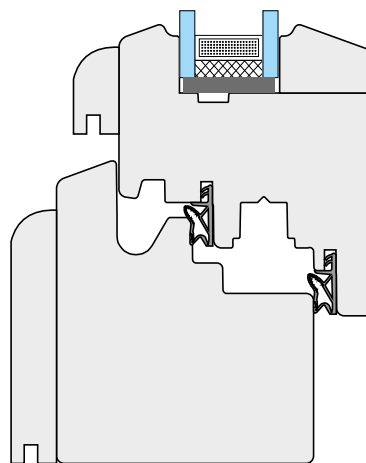

68 DN



R3

-  Stabdardowe frezowanie ramy
-  Standard frame finish
-  Finition de cadre standard
-  Finitura telaio standard
-  Standard-Rahmenausführung

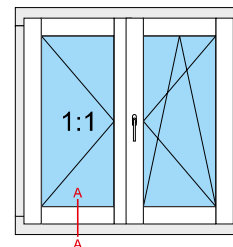



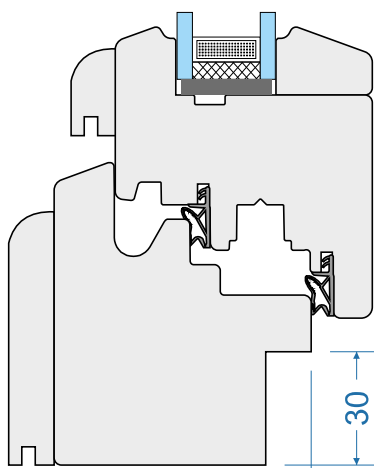

out

in



INT 12x30 +12



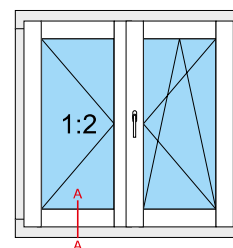

-  Frezy pod parapety
-  Groove for the window sill
-  Rainure pour le rebord de la fenêtre
-  Scanalatura per il davanzale della finestra
-  Nut für die Fensterbank

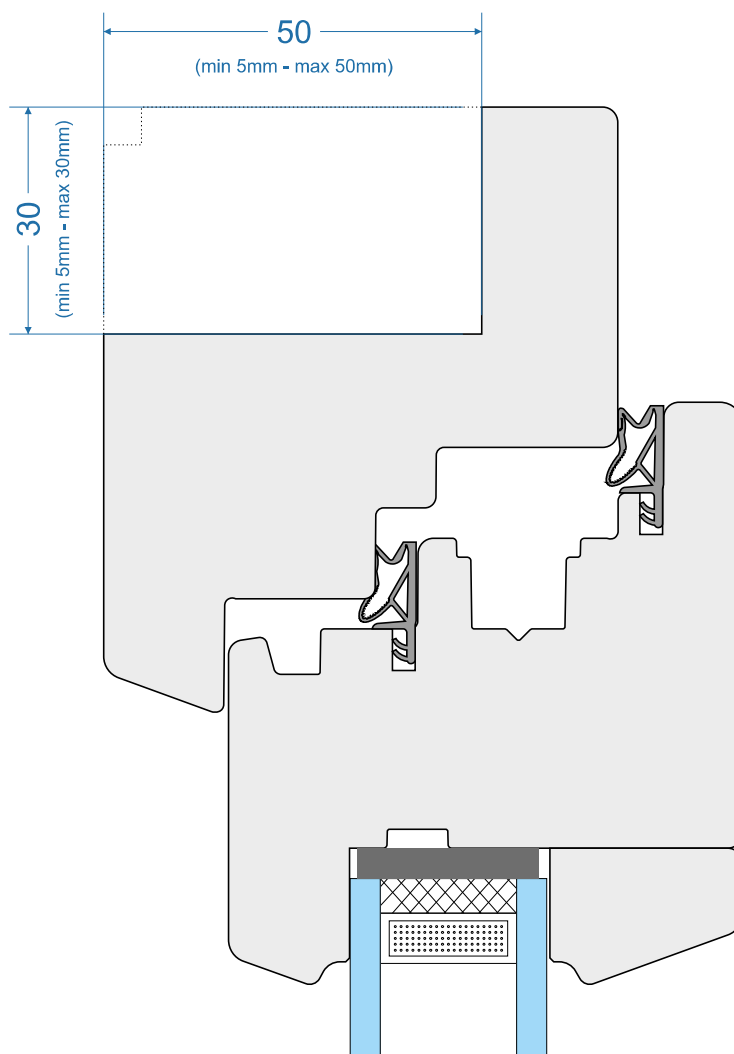

out

in



-  Frez renowacyjny od zewnątrz
-  Renovation groove from the outside
-  Rainure de rénovation à l'extérieur
-  Scanalatura di ristrutturazione all'esterno
-  Renovierungsnut außen

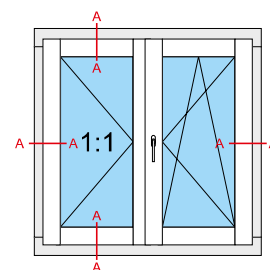

STL-03-68-S-005

Style 02 68mm „S”

Style 02 68mm „R”

Style 03 68mm „S”

Style 03 68mm „R”





French 01

French 02

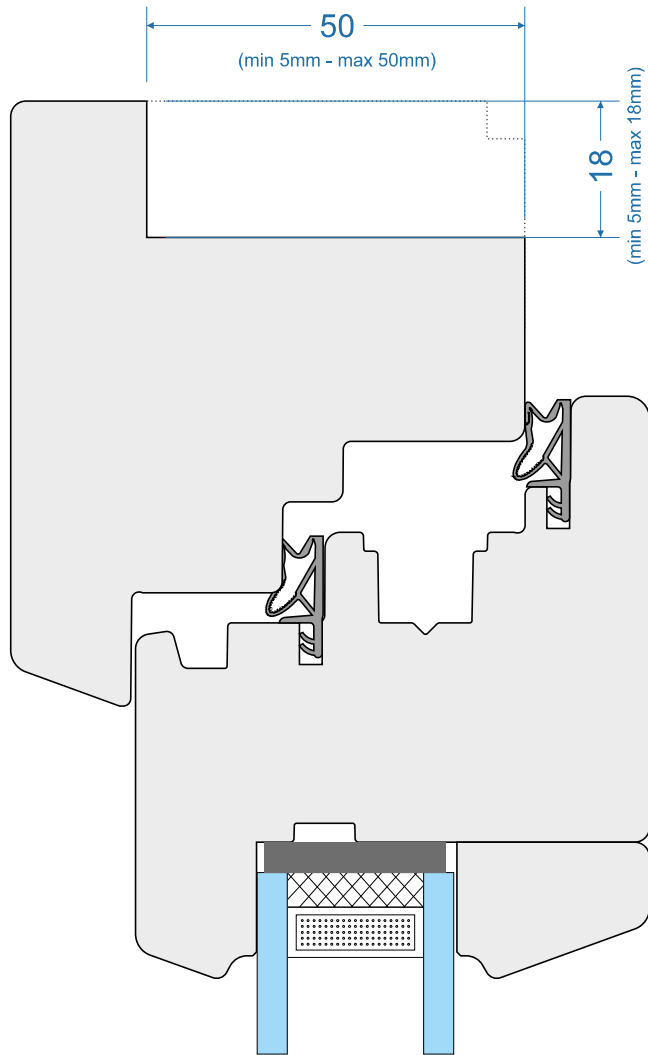
out





in

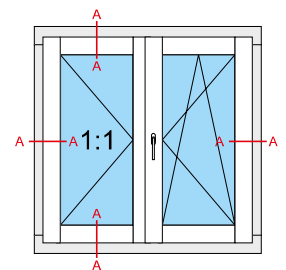

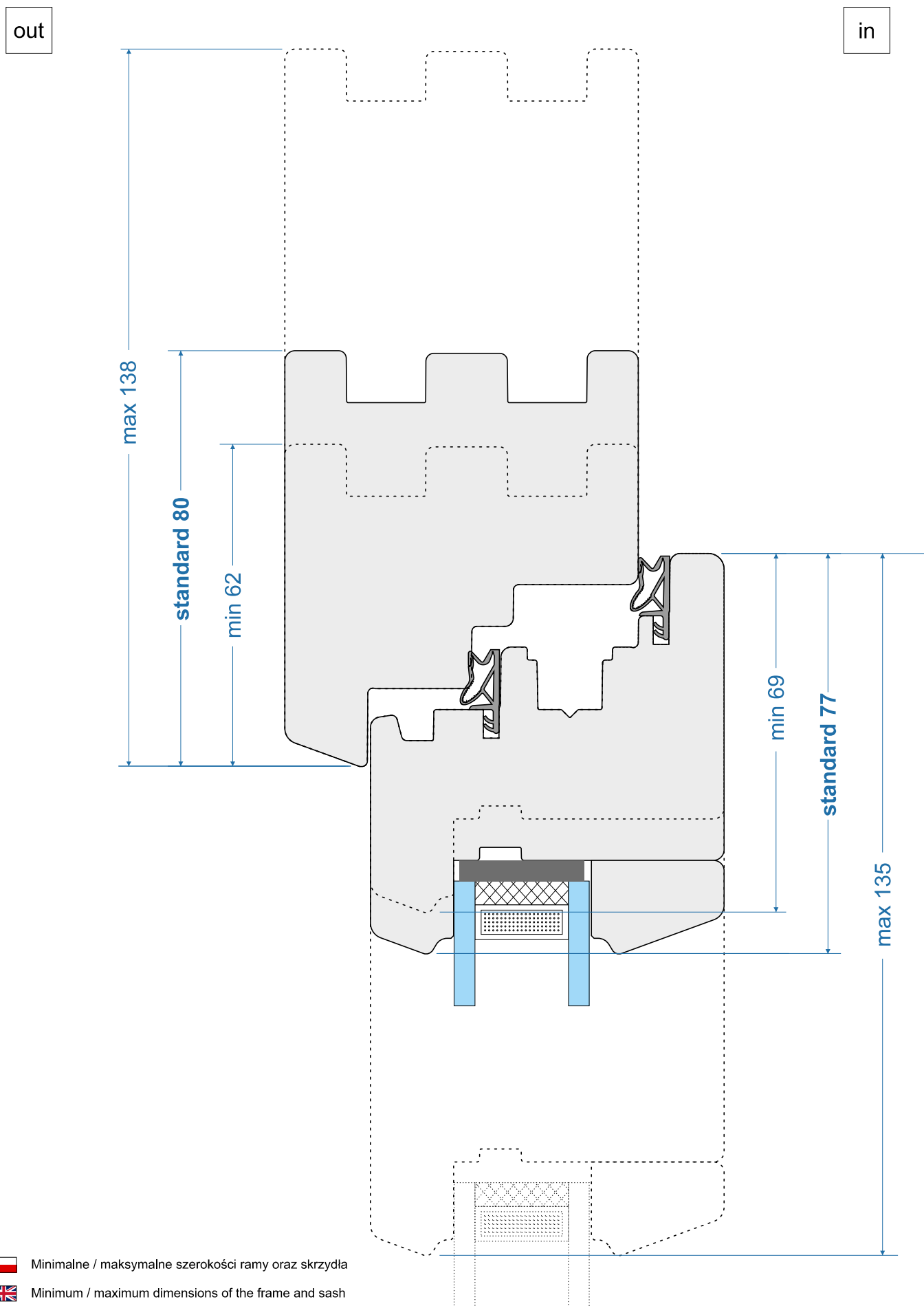
-  Frez renowacyjny od wewnątrz
-  Renovation groove from the inside
-  Rainure de rénovation à l'intérieur
-  Scanalatura di ristrutturazione all'interno
-  Renovierungsnut auf der Innenseite





-  Minimalne / maksymalne szerokości ramy oraz skrzydła
-  Minimum / maximum dimensions of the frame and sash
-  Dimensions minimales / maximales du cadre et du châssis
-  Dimensioni minime/massime del telaio e dell'anta
-  Minimale / maximale breite des rahmen und des flügels

STL-03-68-S-007

Style 02 68mm „S”

Style 02 68mm „R”

Style 03 68mm „S”

Style 03 68mm „R”

French 01

French 02

out

in

Style 02 68mm „S”

Style 02 68mm „R”

Style 03 68mm „S”

Style 03 68mm „R”

French 01

French 02

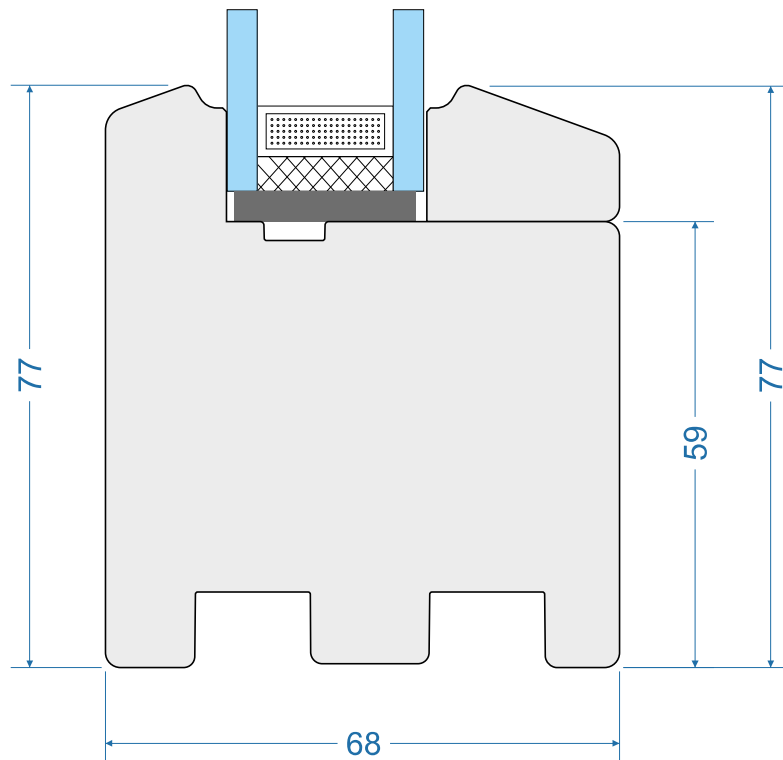

-  Fix w ramie
-  Fixed window
-  Chassis fixe
-  Finestra fissa
-  Fenster fest im rahmen

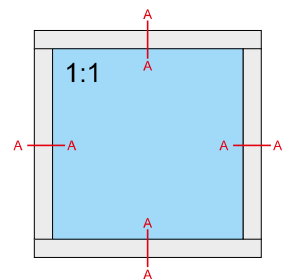

STL-03-68-S-008

out

in

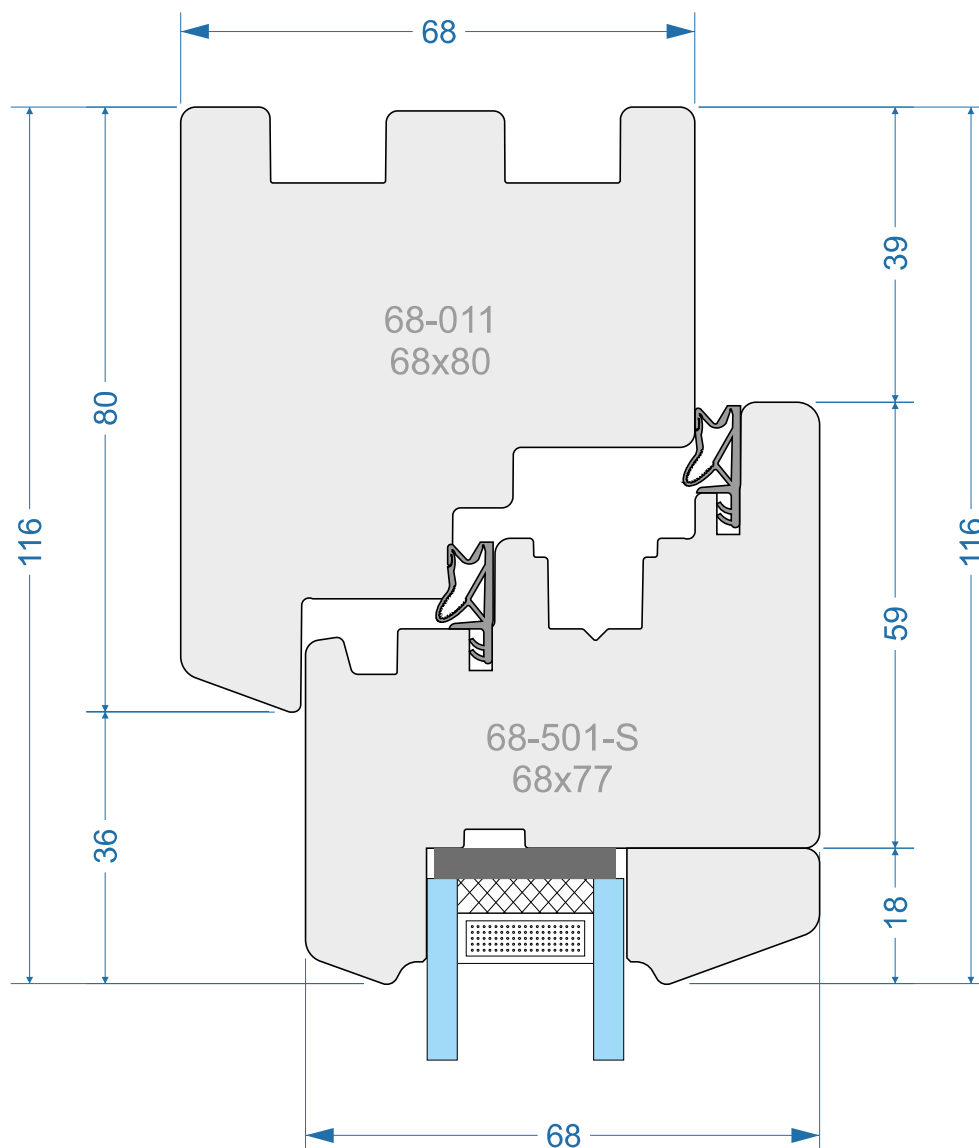

-  Rama + skrzydło
-  Frame + sash
-  Cadre + ouvrant
-  Telaio + anta
-  Rahmen + Flügel

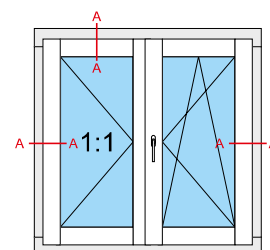

STL-03-68-S-009

Style 02 68mm „S”

Style 02 68mm „R”

Style 03 68mm „S”

Style 03 68mm „R”

French 01

French 02

out

in

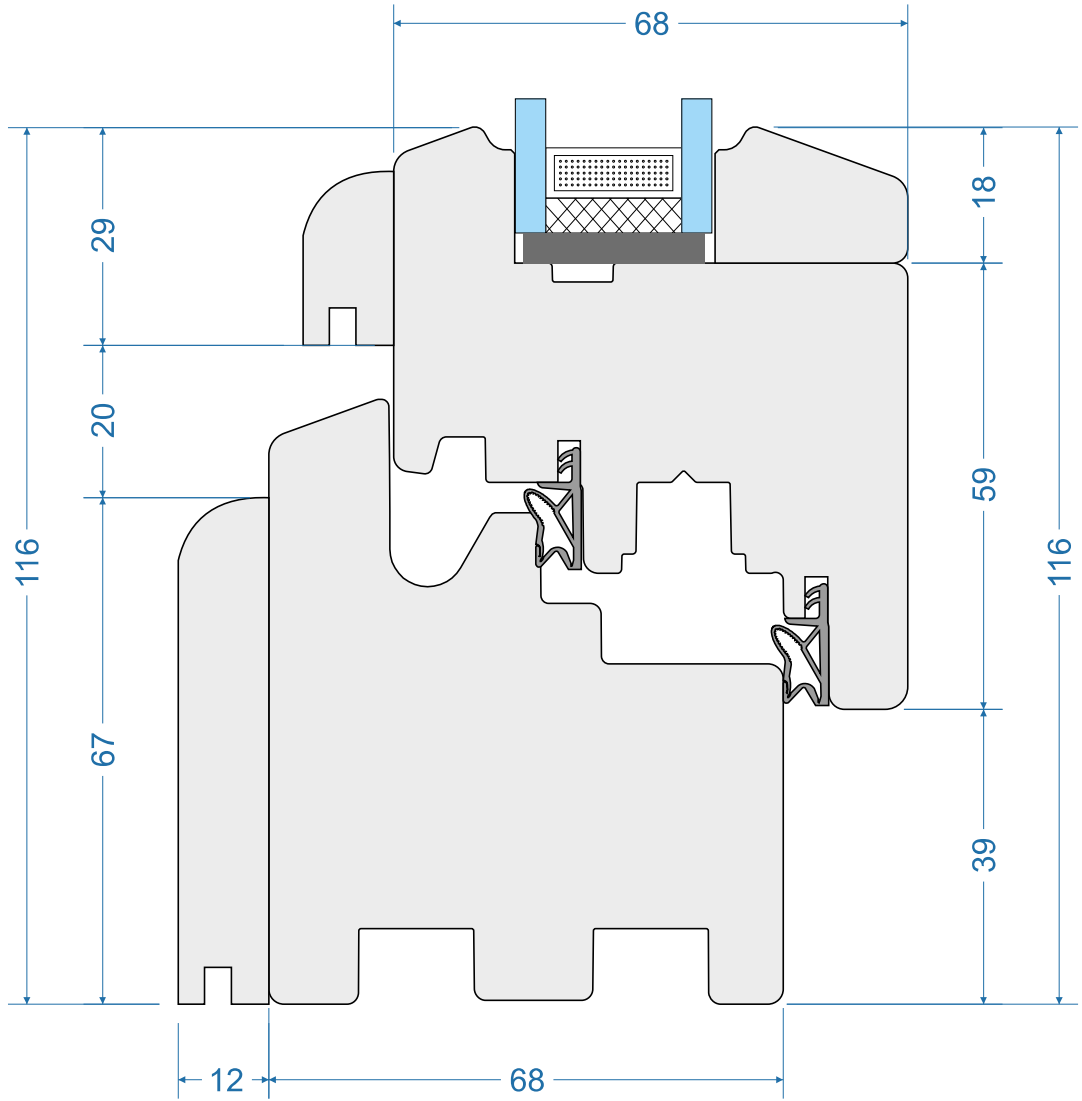

-  Rama + skrzydło
-  Frame + sash
-  Cadre + ouvrant
-  Telaio + anta
-  Rahmen + Flügel

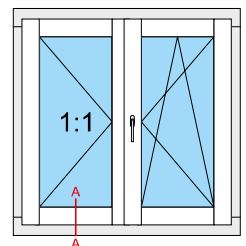

out

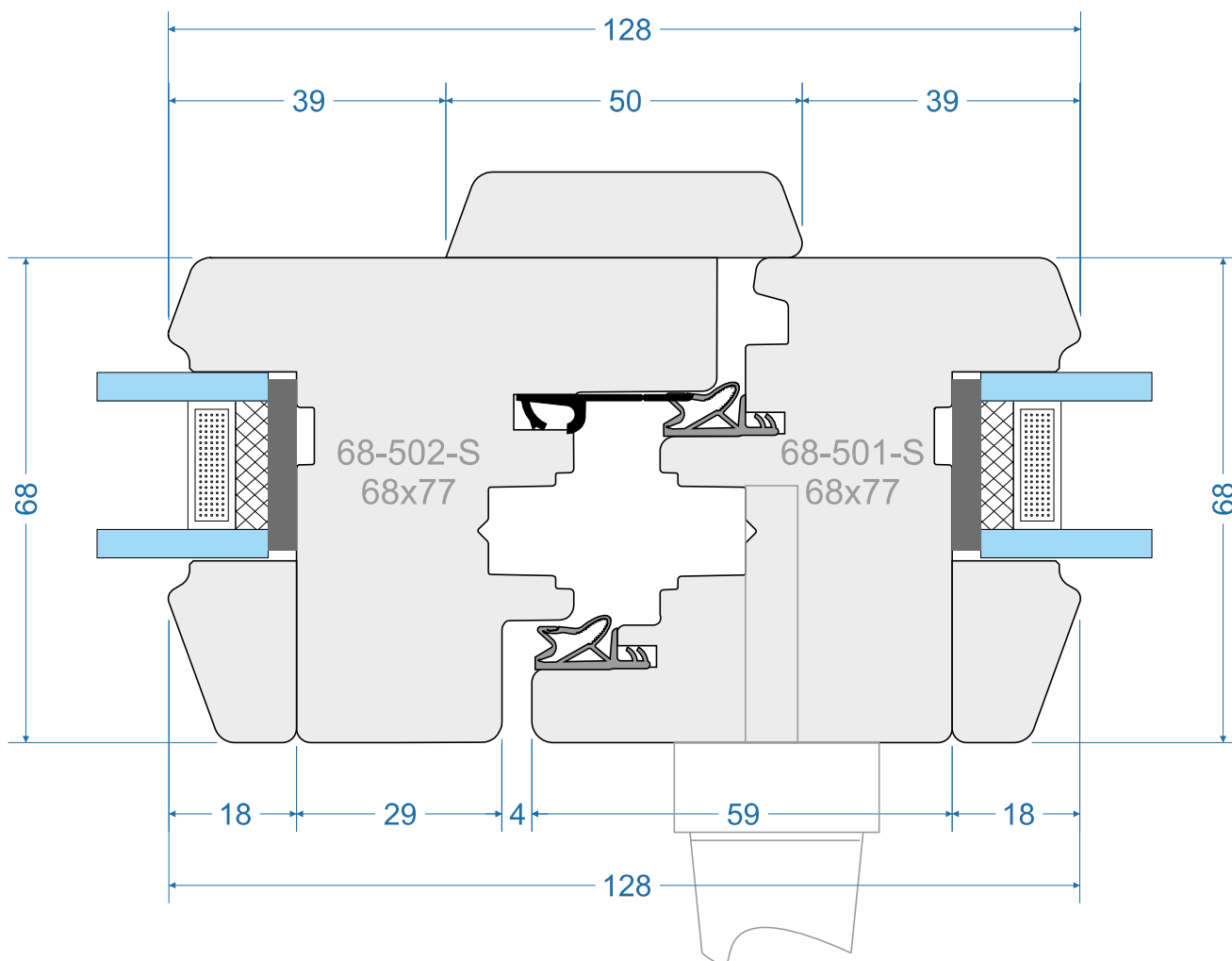

in

-  Stupek ruchomy
-  Moveable post
-  Meneau mobile
-  Montante mobile
-  Stulp

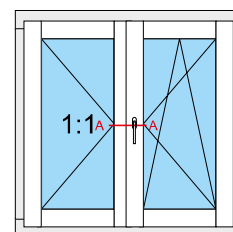

STL-03-68-S-0011

Style 02 68mm „S”

Style 02 68mm „R”

Style 03 68mm „S”

Style 03 68mm „R”



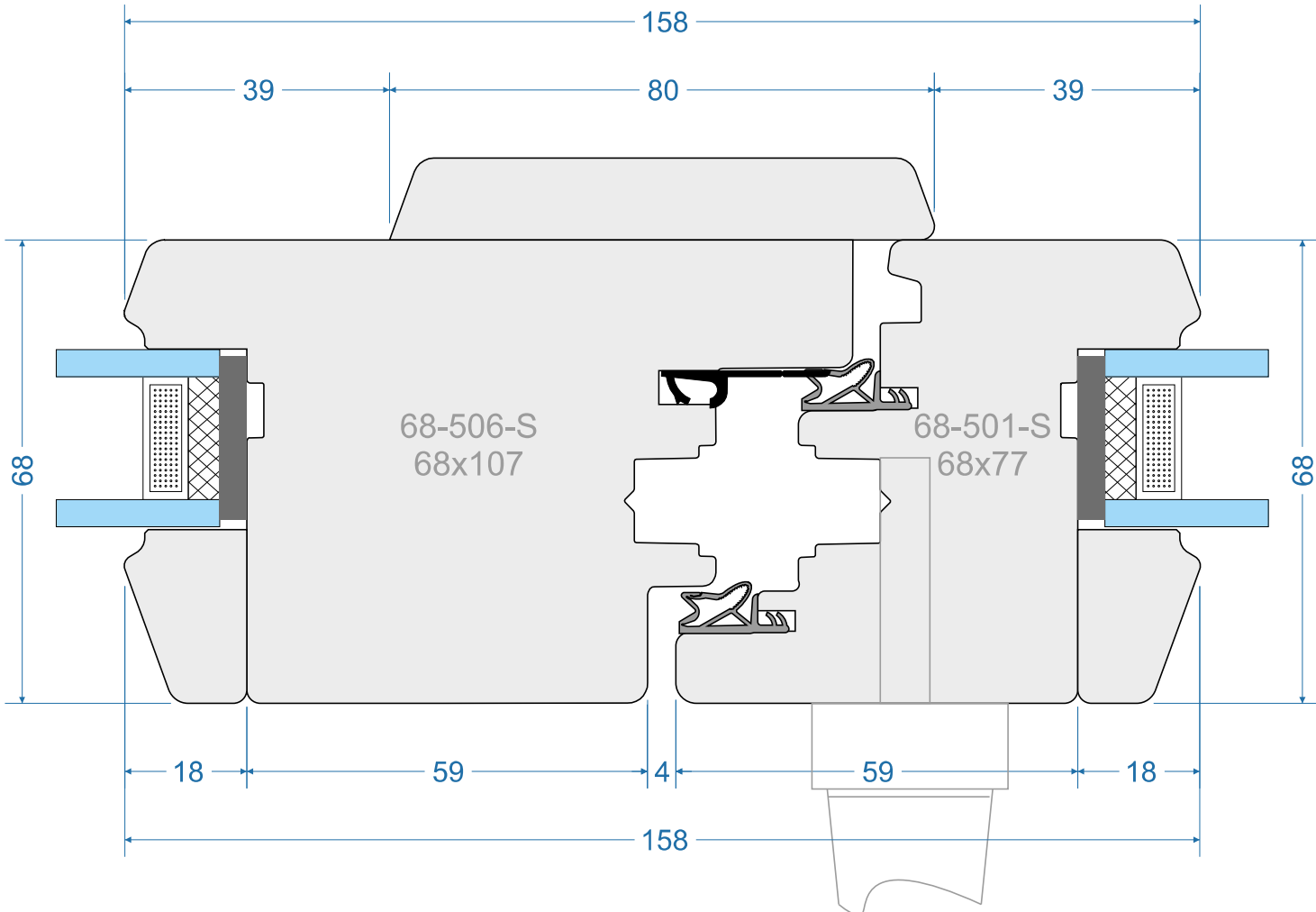

French 01

French 02

out



in



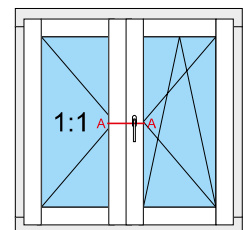

-  Stupek ruchomy - równe elementy
-  Movable post - equal elements
-  Meneau mobile - éléments égaux
-  Montante mobile - elementi simmetrici
-  Stulp - gleiche Elemente

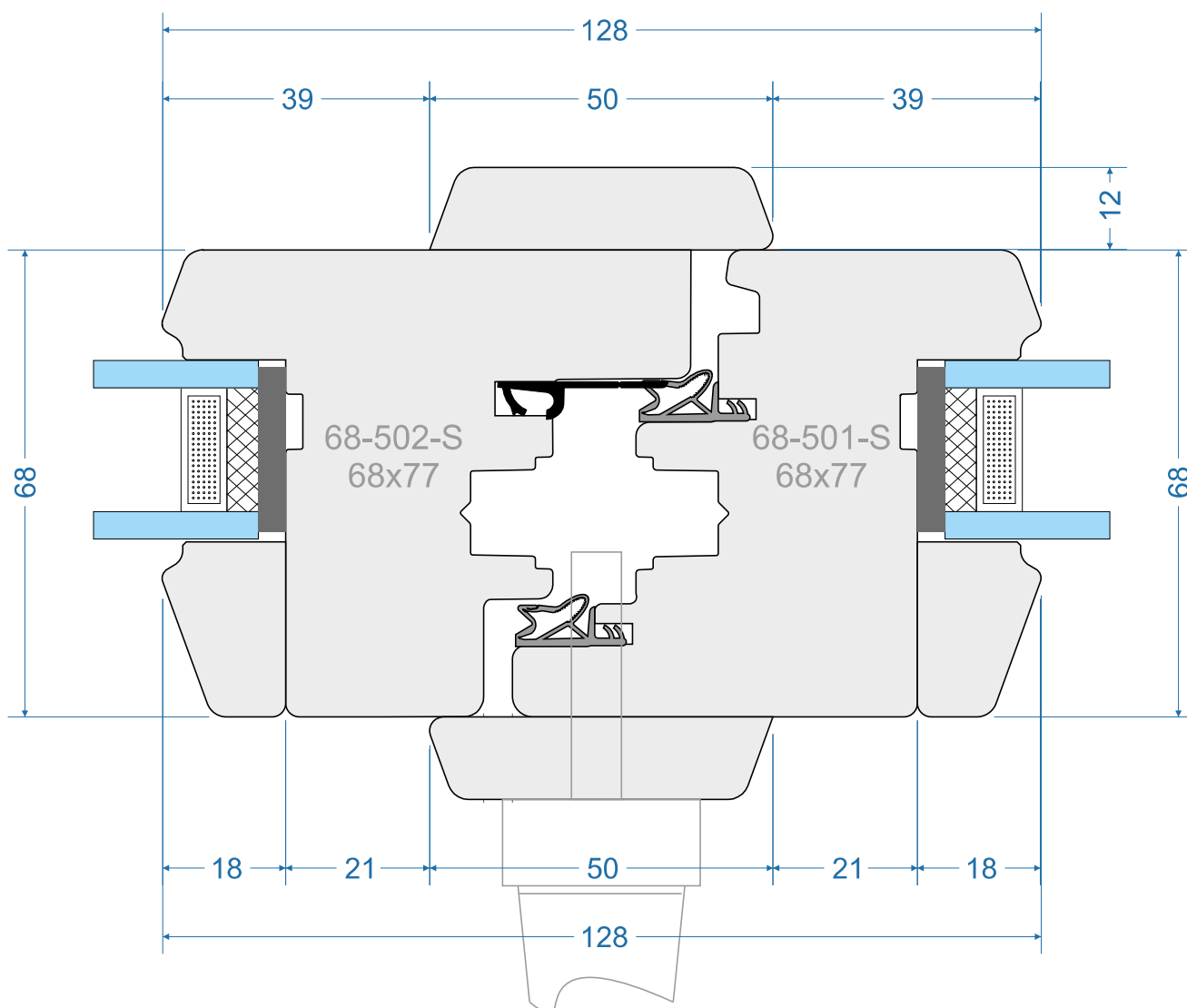

out



in

-  Stupek ruchomy - klamka centralna
-  Moveable post - central handle
-  Meneau mobile - poignée centrale
-  Montante mobile - maniglia centrale (entrata zero)
-  Stulp - zentraler Griff

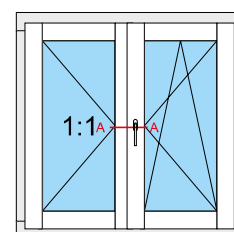

STL-03-68-S-0013

Style 02 68mm „S”

Style 02 68mm „R”

Style 03 68mm „S”

Style 03 68mm „R”

French 01

French 02

out

Style 02 68mm „S”

Style 02 68mm „R”

Style 03 68mm „S”



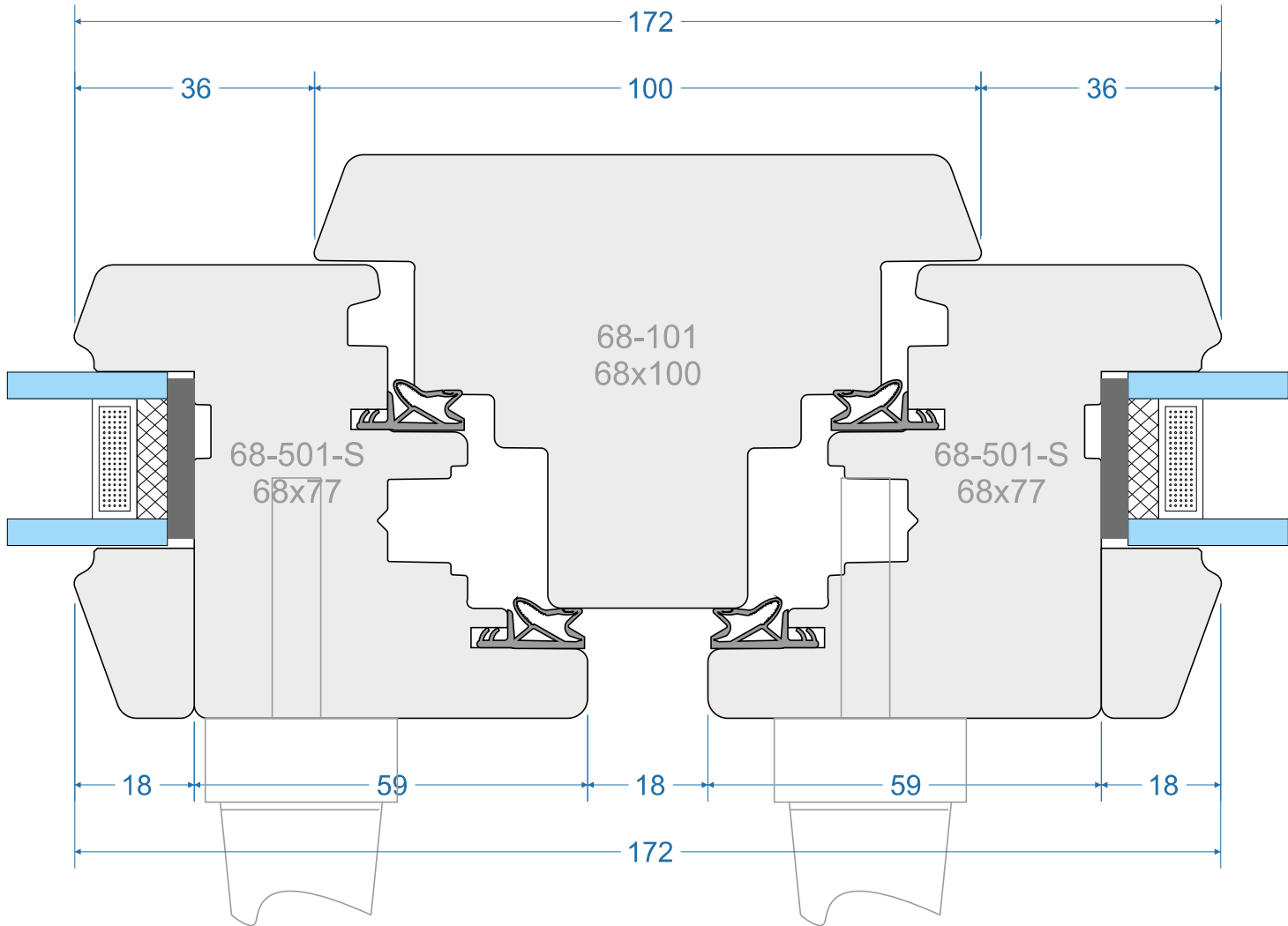

Style 03 68mm „R”

French 01

French 02



in

-  Stupek staly 100mm
-  Fixed post 100mm
-  Meneau fixe 100mm
-  Montante verticale fisso 100mm
-  Festen pfosten 100mm

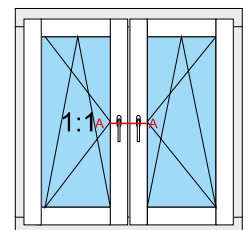

out

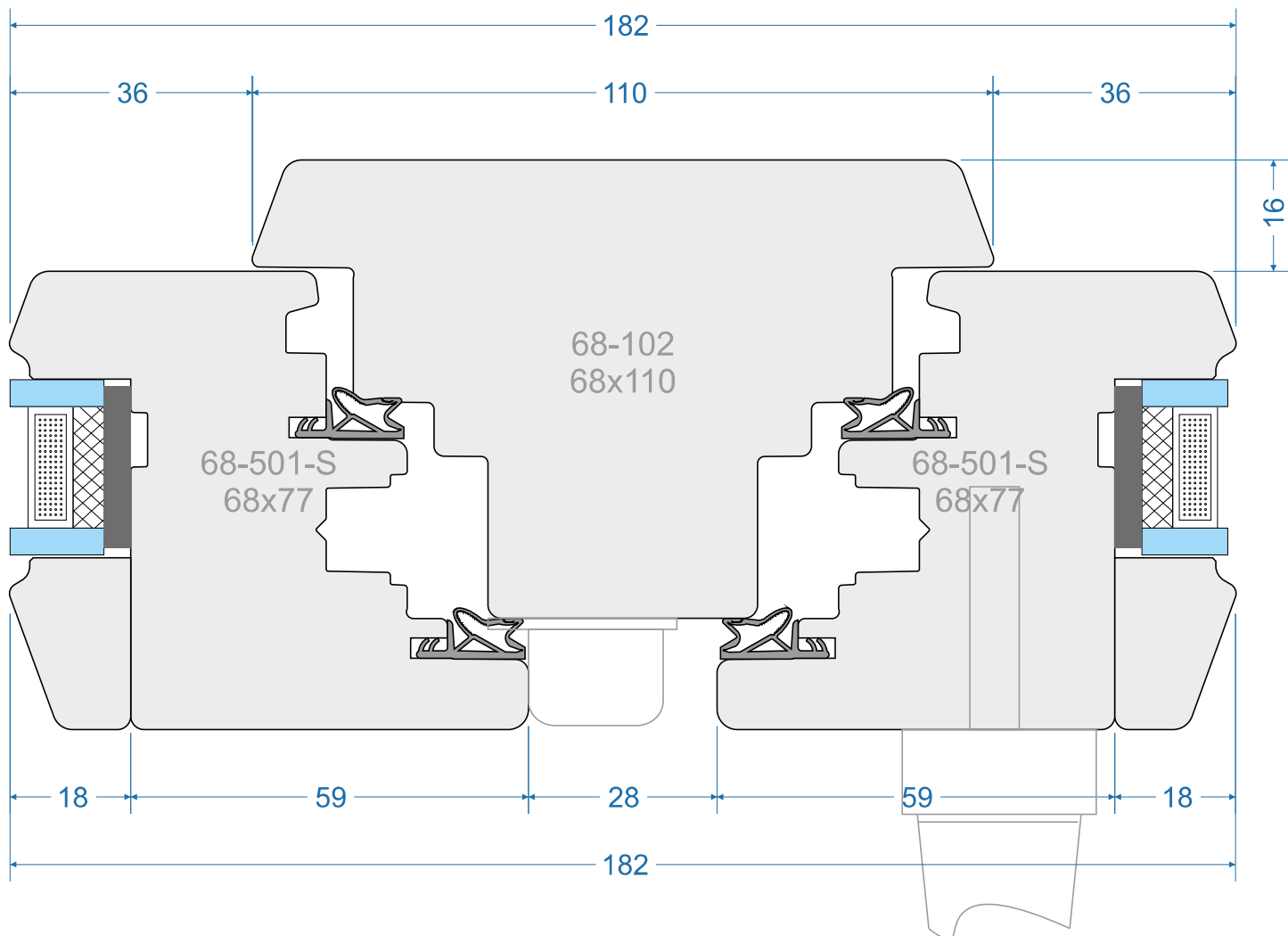

in

-  Słupek stalowy 110mm
-  Fixed post 110mm
-  Meneau fixe 110mm
-  Montante verticale fisso 110mm
-  Festen pfosten 110mm

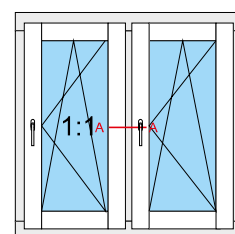

STL-03-68-S-0015

Style 02 68mm „S”

Style 02 68mm „R”

Style 03 68mm „S”

Style 03 68mm „R”

French 01





French 02

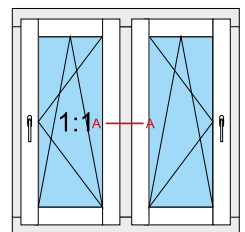
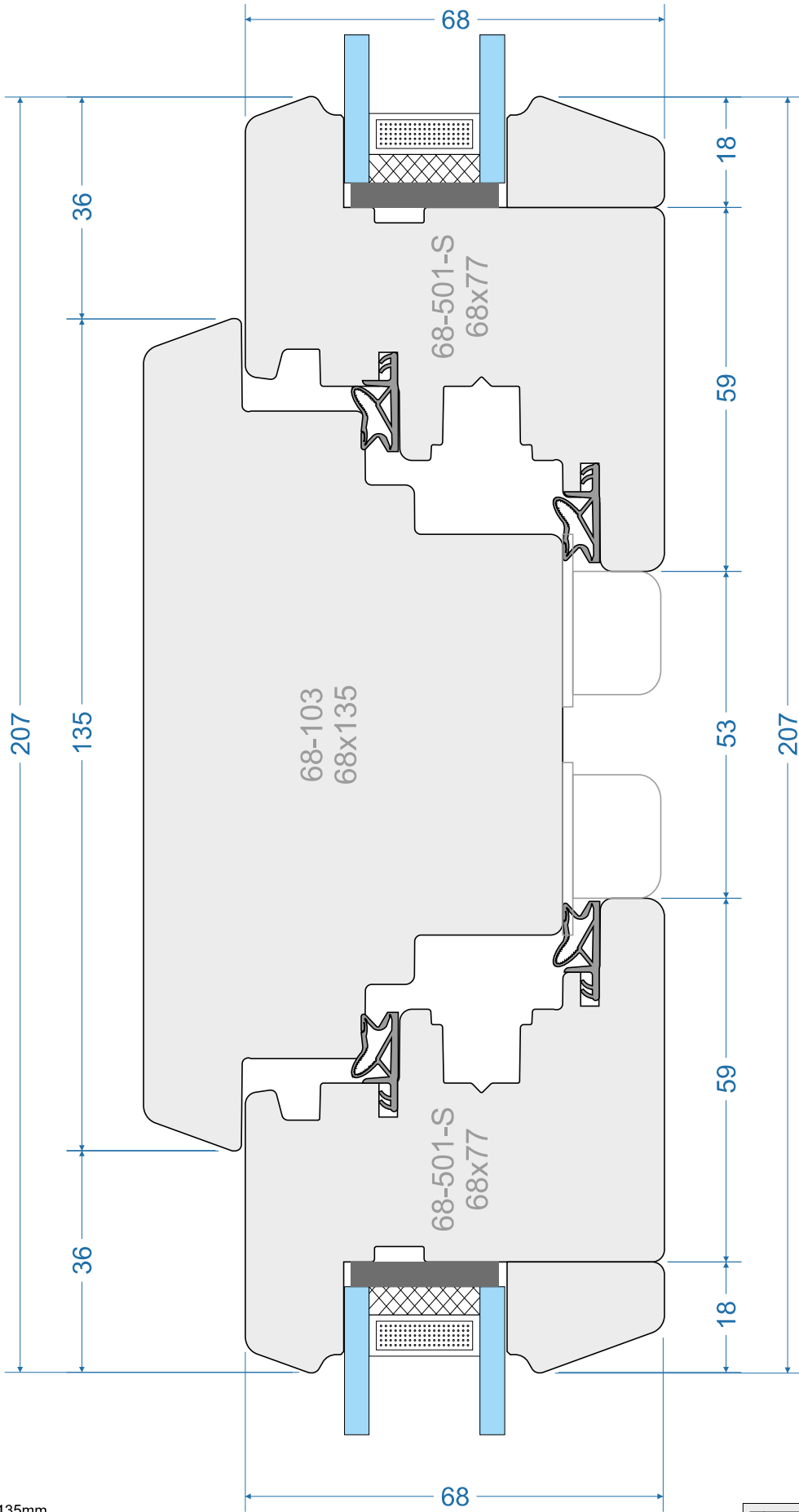

out

in





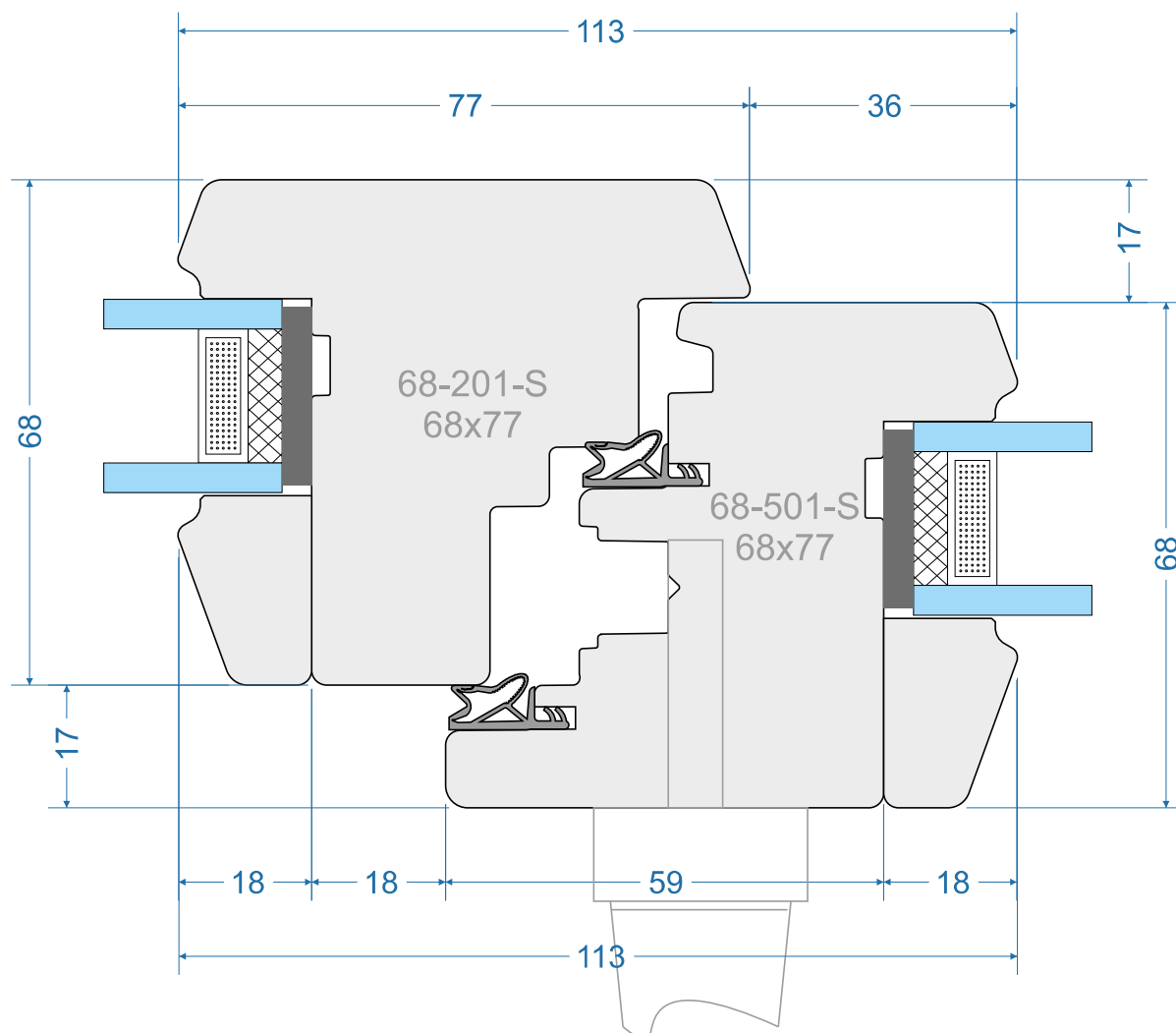

-  Slupek staly 135mm
-  Fixed post 135mm
-  Meneau fixe 135mm
-  Montante orizzontale fisso 135mm
-  Festen pfosten 135mm

out



in

-  Słupek - skrzydło + fix
-  Post - sash + fix
-  Meneau - ouvrant + fixe
-  Accoppiamento telaio fisso - anta mobile
-  Pfosten - Flügel + Fix

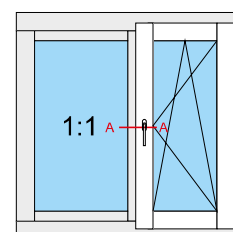

STL-03-68-S-0017

Style 02 68mm „S”

Style 02 68mm „R”

Style 03 68mm „S”

Style 03 68mm „R”



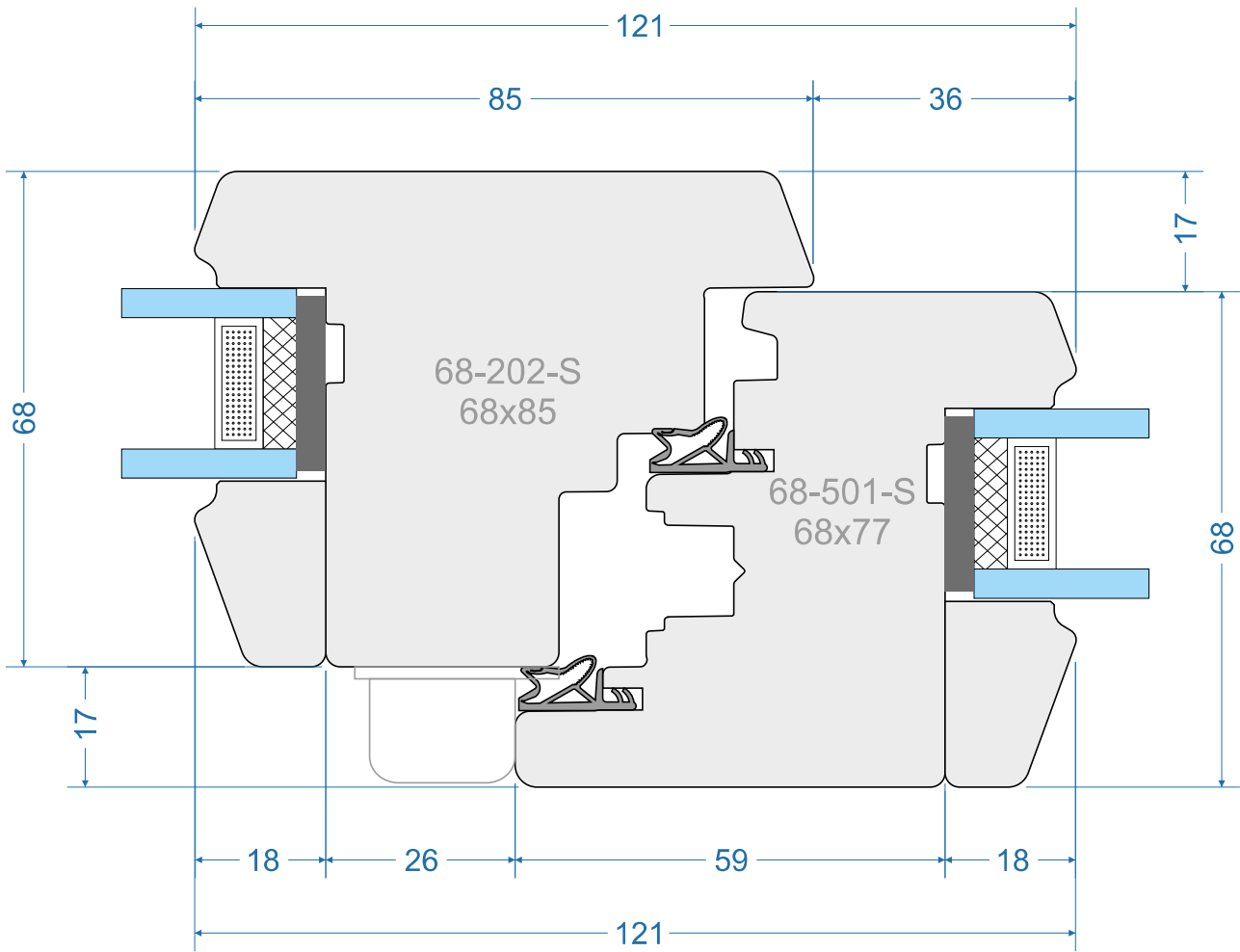

French 01

French 02

out



in

-  Stupek - skrzydło + fix
-  Post - sash + fix
-  Meneau - ouvrant+ fixe
-  Accoppiamento telaio fisso - anta mobile
-  Pfosten - Flügel + Fix

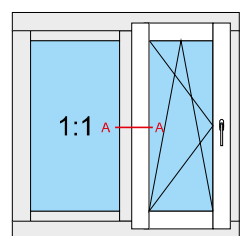

Style 02 68mm „S”

Style 02 68mm „R”

Style 03 68mm „S”

Style 03 68mm „R”

French 01

French 02

out

in

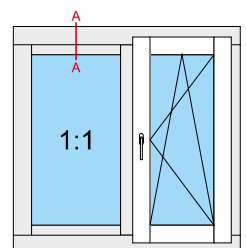
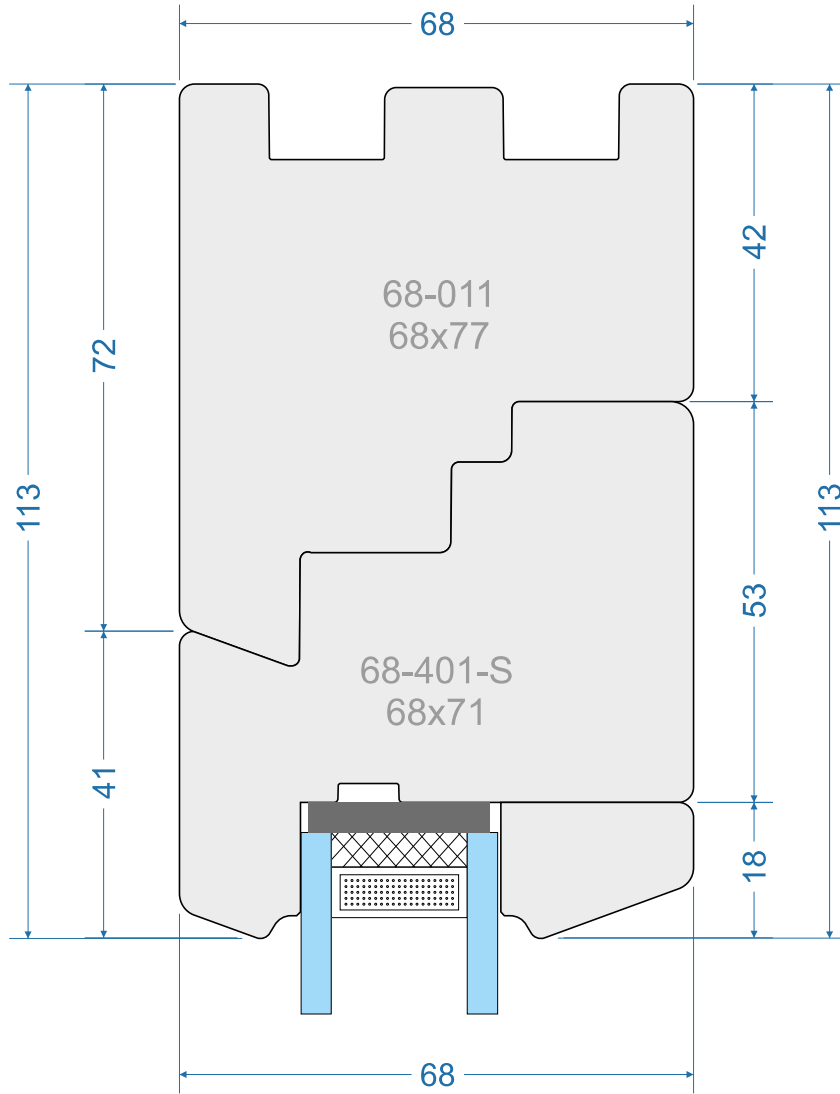

-  Wyrównanie górne
-  Top alignment
-  Alignement supérieur
-  Allineamento superiore
-  Ausrichtung nach oben

STL-03-68-S-0019

Style 02 68mm „S”

Style 02 68mm „R”

Style 03 68mm „S”

Style 03 68mm „R”

French 01

French 02

out

in

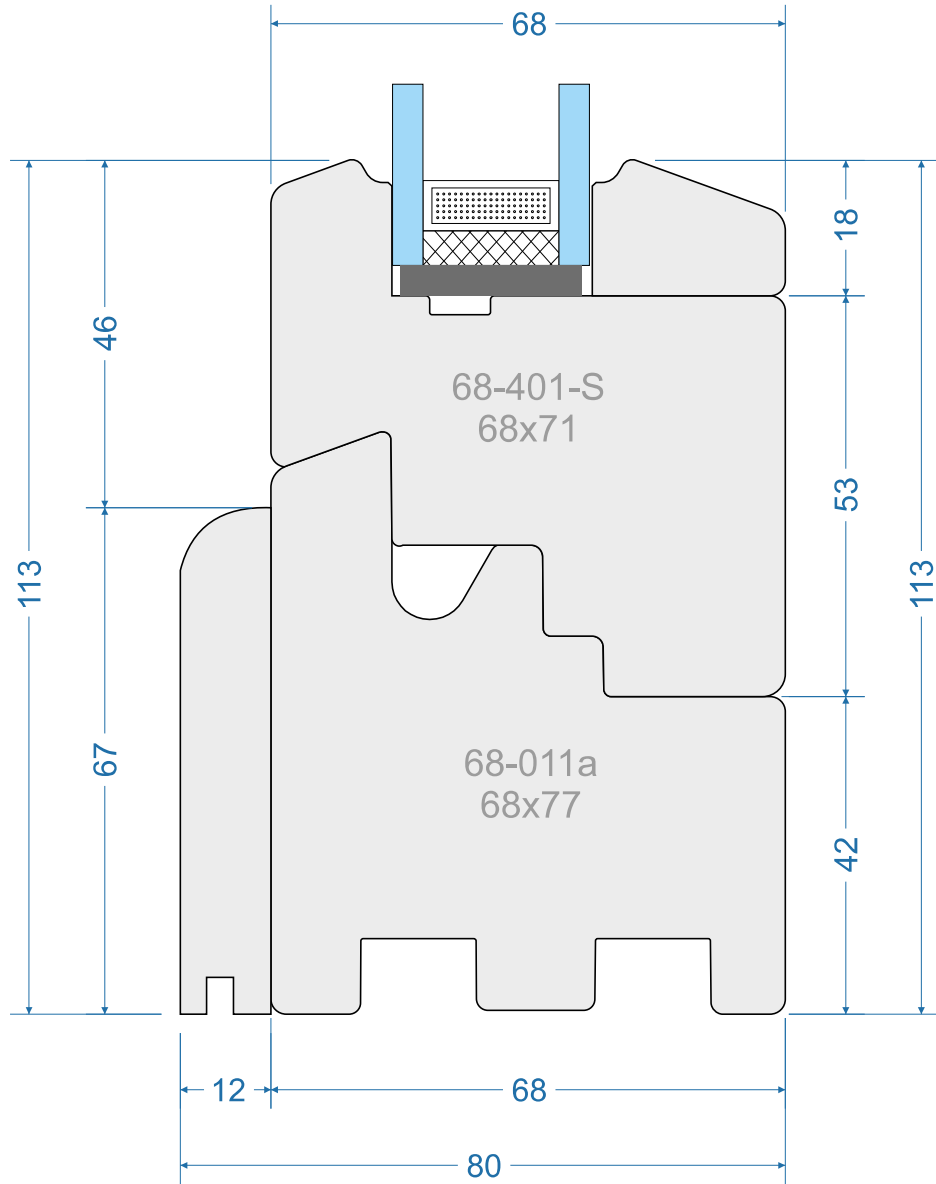



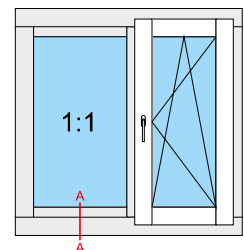



-  Wyrównanie dolne
-  Bottom alignment
-  Alignement en bas
-  Allineamento inferiore
-  Ausrichtung nach unten

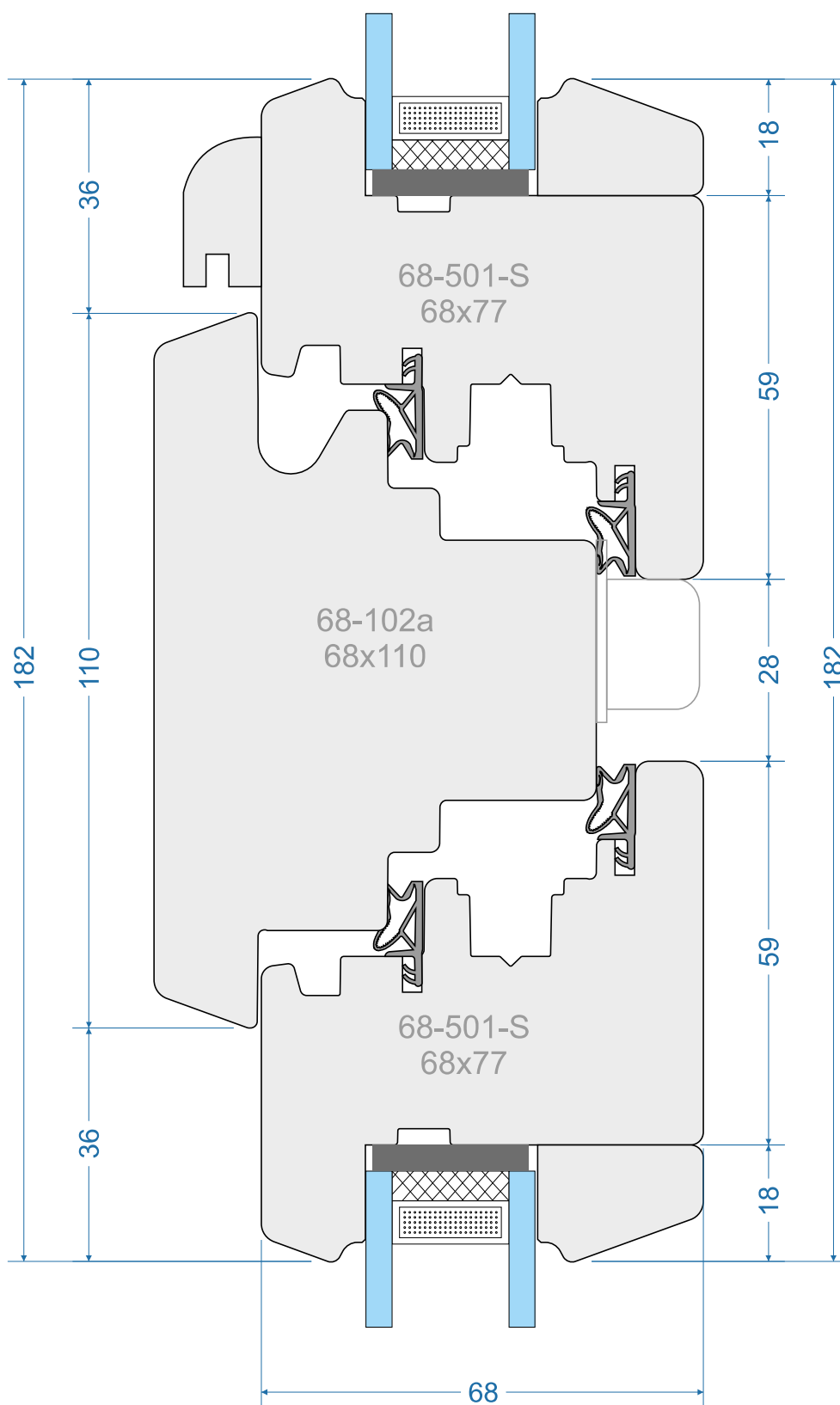

out

in



-  Słupek poziomy - skrzydło + skrzydło
-  Horizontal post - sash + sash
-  Traverse - ouvrant + ouvrant
-  Montante orizzontale - anta + anta
-  Horizontaler Pfosten - Flügel + Flügel

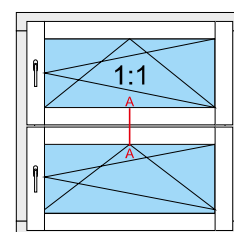

STL-03-68-S-0021

Style 02 68mm „S”

Style 02 68mm „R”

Style 03 68mm „S”

Style 03 68mm „R”





French 01

French 02

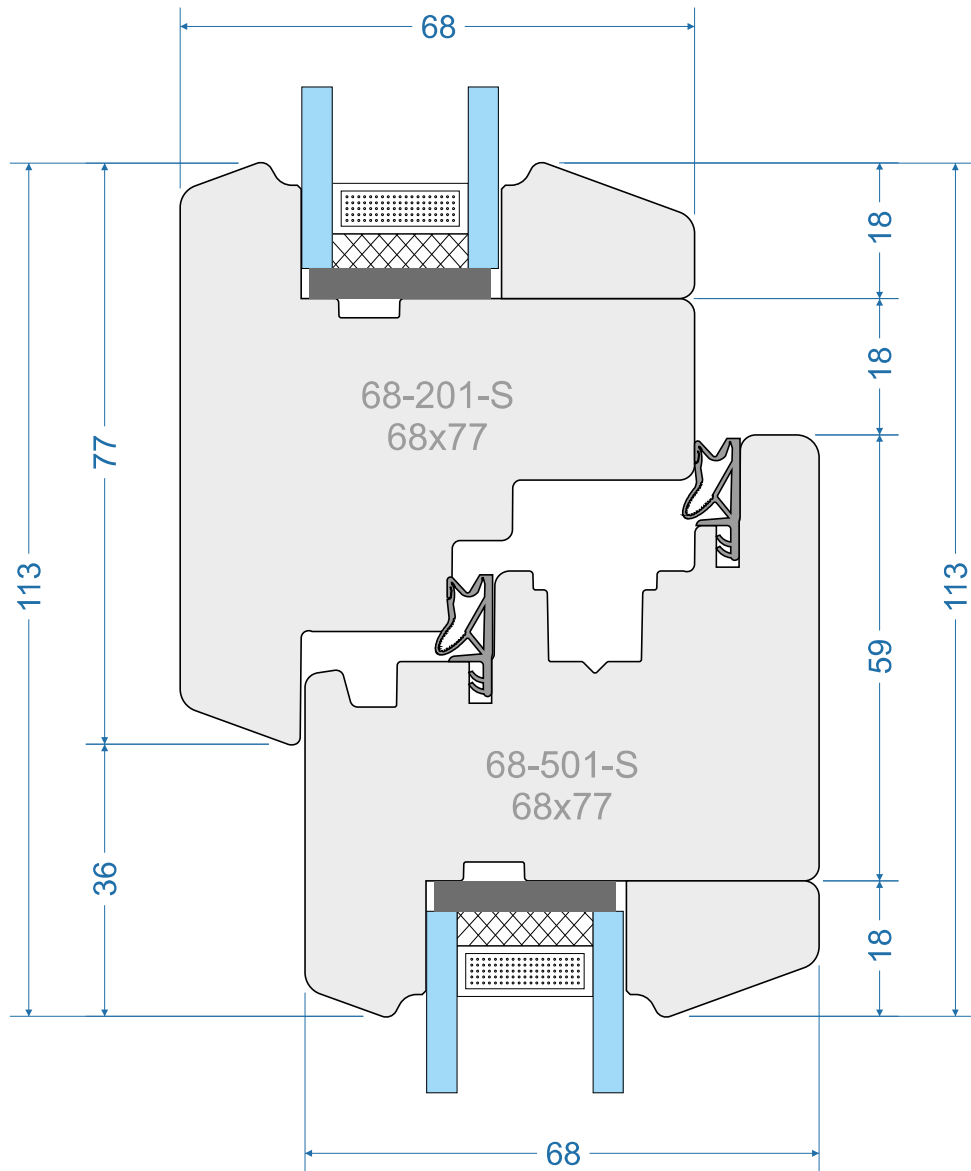
out

in



-  Słupek poziomy - fix + skrzydło
-  Horizontal post - fix + sash
-  Traverse - fixe + ouvrant
-  Montante orizzontale - fisso + anta
-  Horizontaler Pfosten - Fix + Flügel

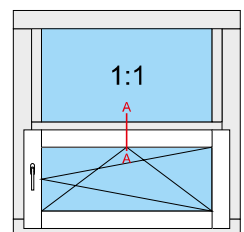



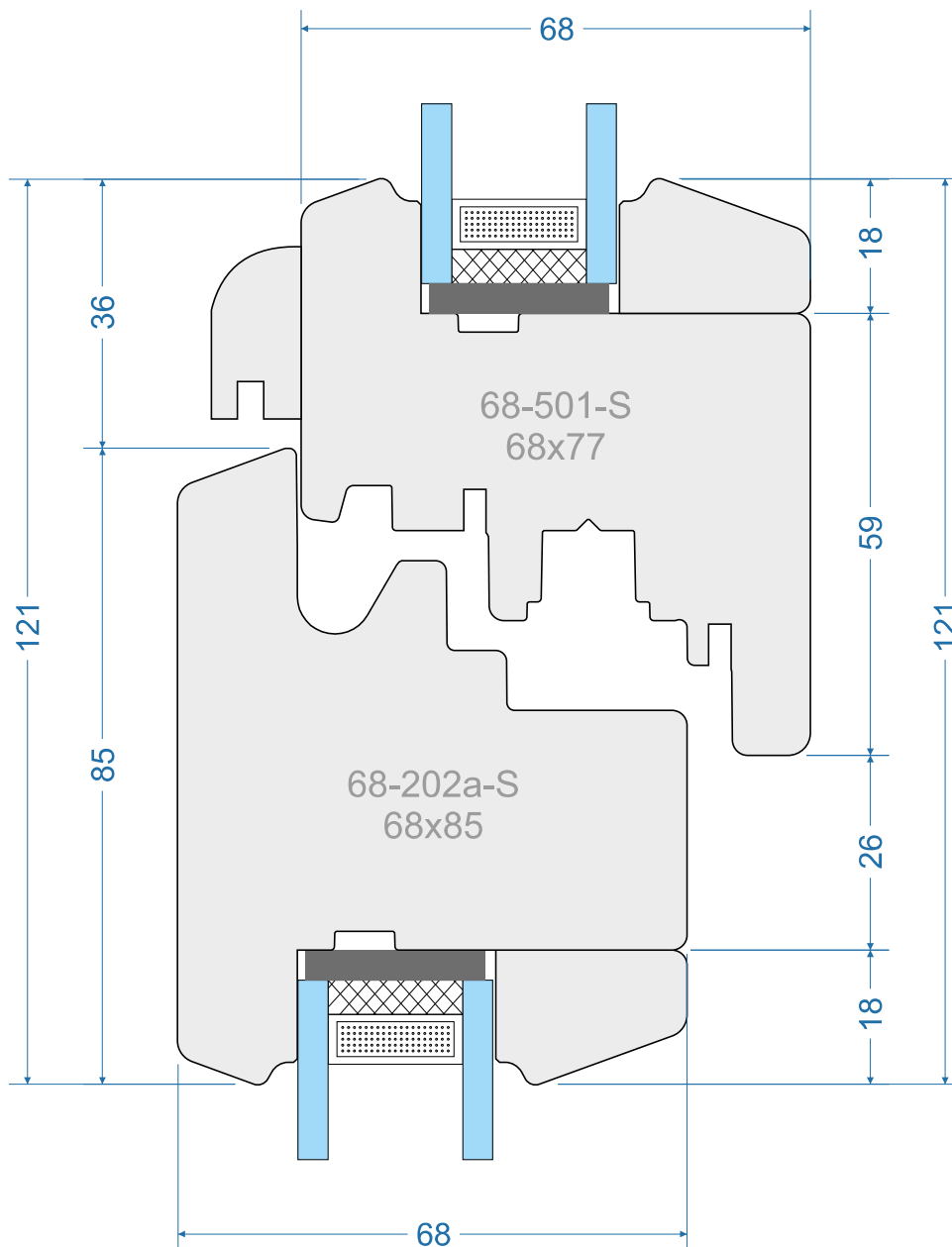

STL-03-68-S-0022

out

in



-  Słupek poziomy - skrzydło + fix
-  Horizontal post - sash + fix
-  Traverse- ouvrant + fixe
-  Montante orizzontale - anta + fisso
-  Horizontaler Pfosten - Flügel + Fix

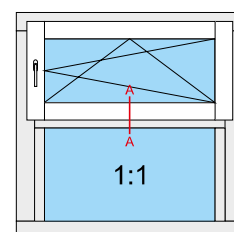

STL-03-68-S-0023

Style 02 68mm „S”

Style 02 68mm „R”

Style 03 68mm „S”

Style 03 68mm „R”

French 01

French 02

out

in

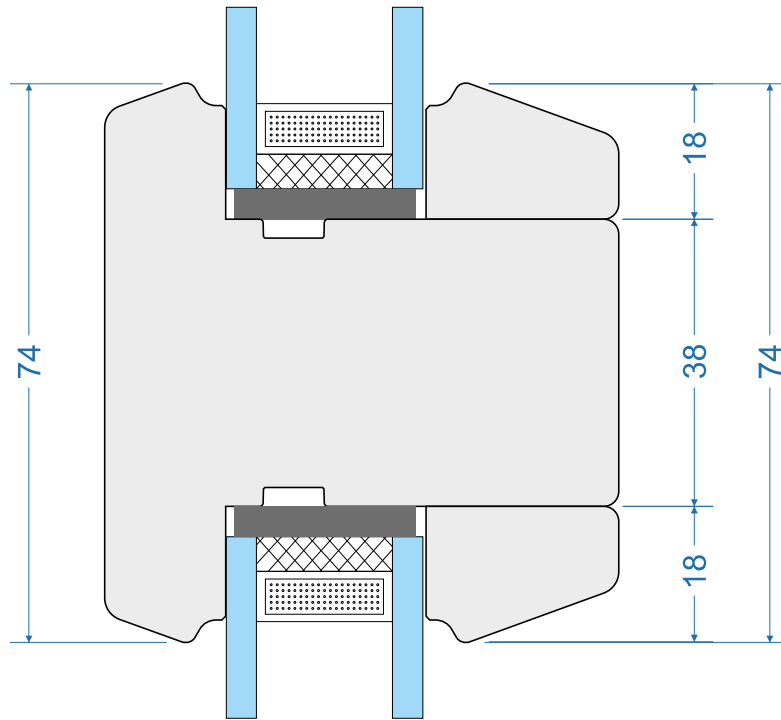



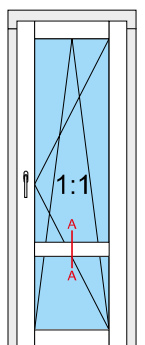



-  Poprzeczka
-  Bar
-  Traversine
-  Traverso
-  Bar

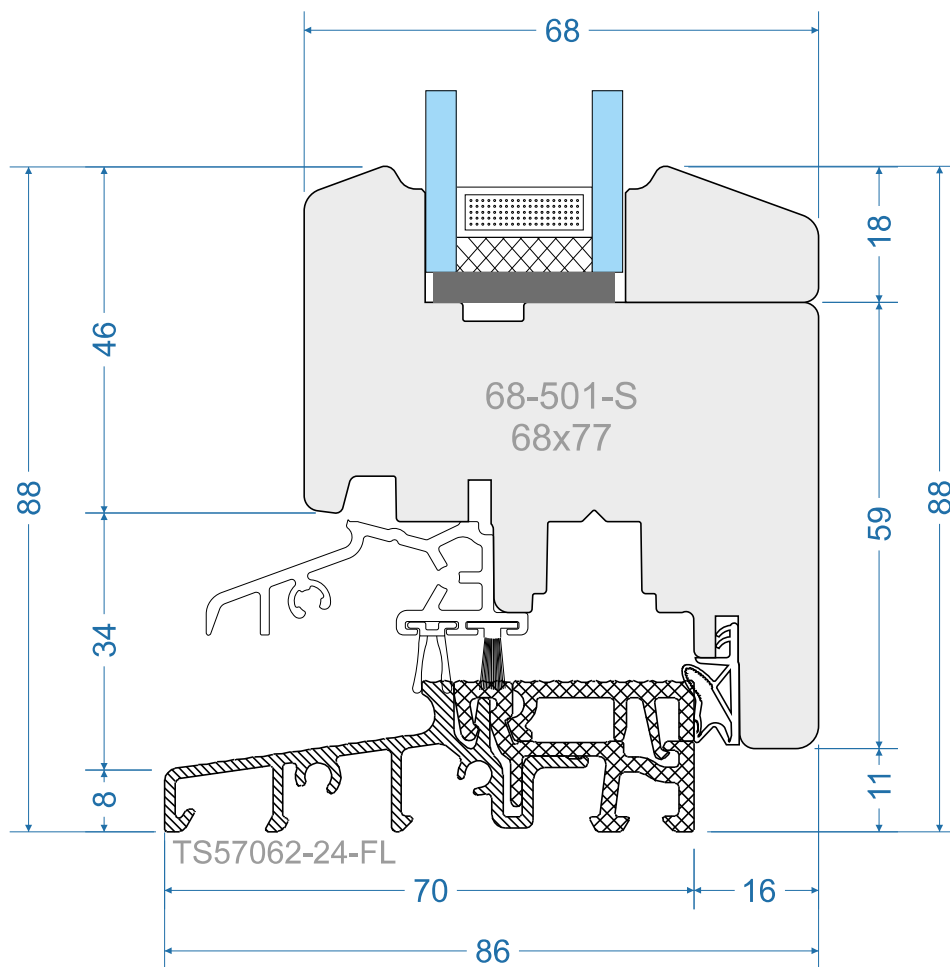

out

in



-  Próg aluminiowy + skrzydło 77mm
-  Aluminum threshold + sash 77mm
-  Seuil en aluminium + châssis 77mm
-  Soglia in alluminio + anta 77mm
-  Aluminiumschwelle + Flügel 77mm

STL-03-68-S-0025

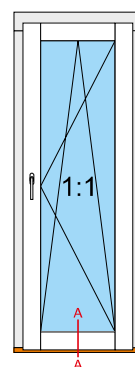

Style 02 68mm „S”

Style 02 68mm „R”

Style 03 68mm „S”

Style 03 68mm „R”





French 01

French 02

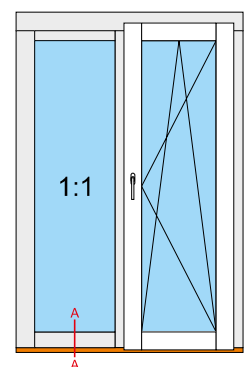
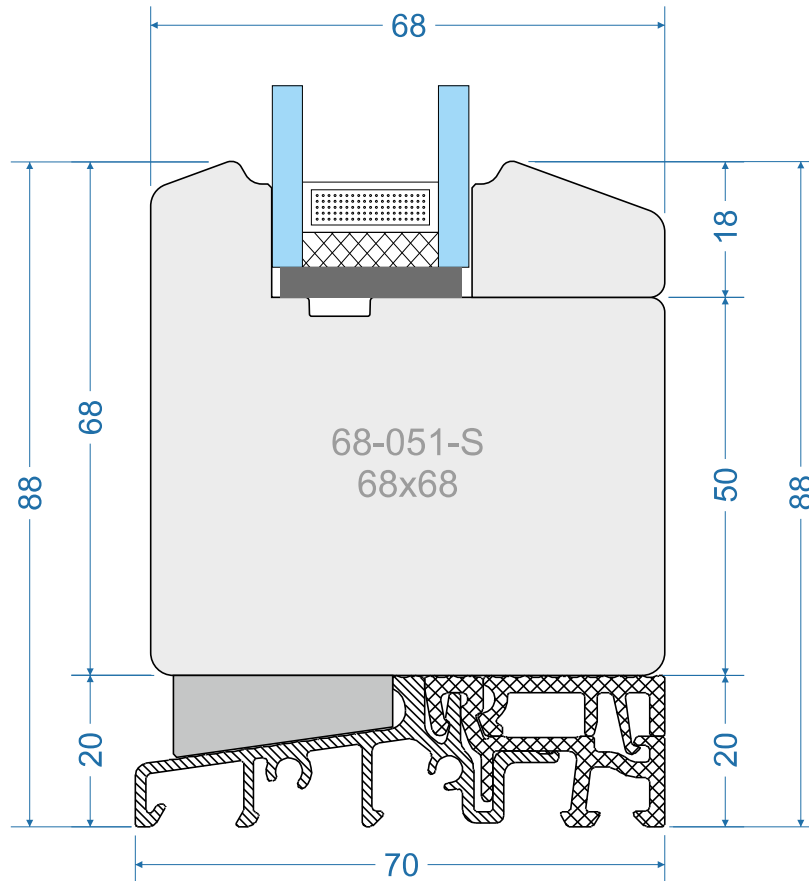
out

in







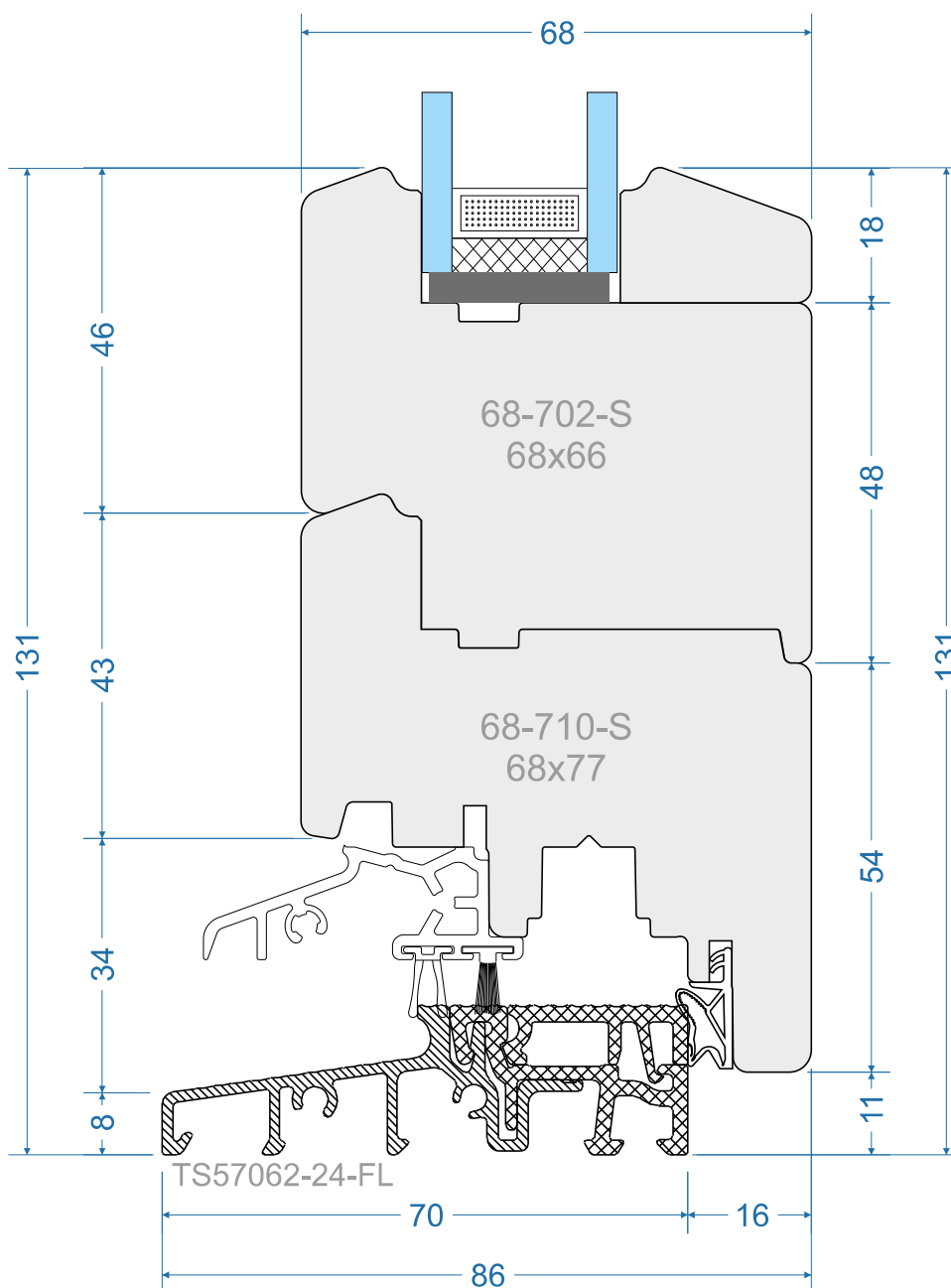

-  Wyrównanie do „Próg aluminiowy + skrzydło 77mm”
-  Alignment to „Aluminum threshold + sash 77mm”
-  Alignement sur le „Seuil en aluminium + châssis 77mm”
-  Allineamento alla „Soglia in alluminio + anta 77mm”
-  Ausrichtung an der „Aluminiumschwelle + Flügel 77mm”

STL-03-68-S-0026

out

in



-  Próg aluminiowy + skrzydło 77mm + cokół 66mm
-  Aluminum threshold + sash 77mm + plinth 66mm
-  Seuil en aluminium + châssis 77mm + socle 66mm
-  Soglia in alluminio + anta 77mm + zoccolo 66mm
-  Aluminiumschwelle + Flügel 77mm + Sockel 66mm

STL-03-68-S-0027

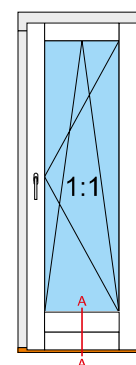

Style 02 68mm „S”

Style 02 68mm „R”

Style 03 68mm „S”

Style 03 68mm „R”





French 01

French 02

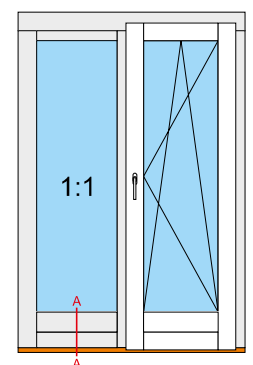
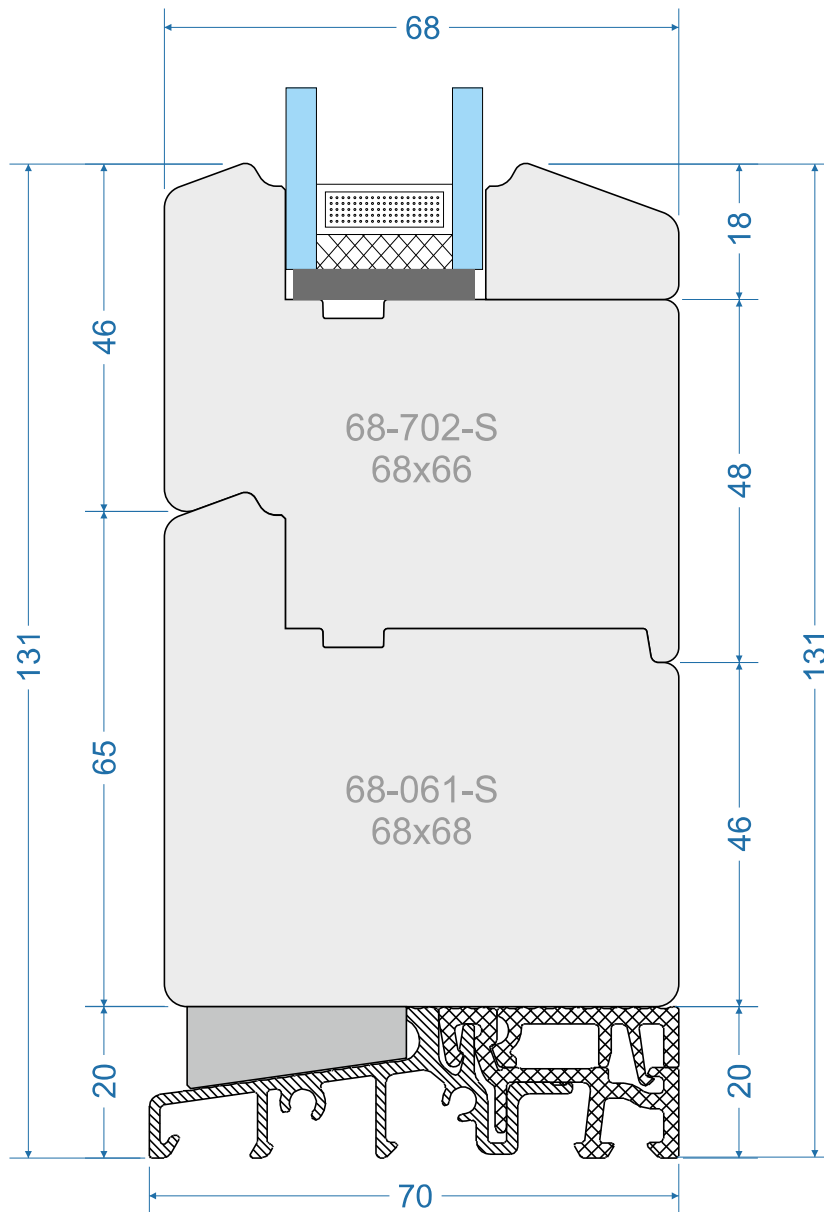
out

in







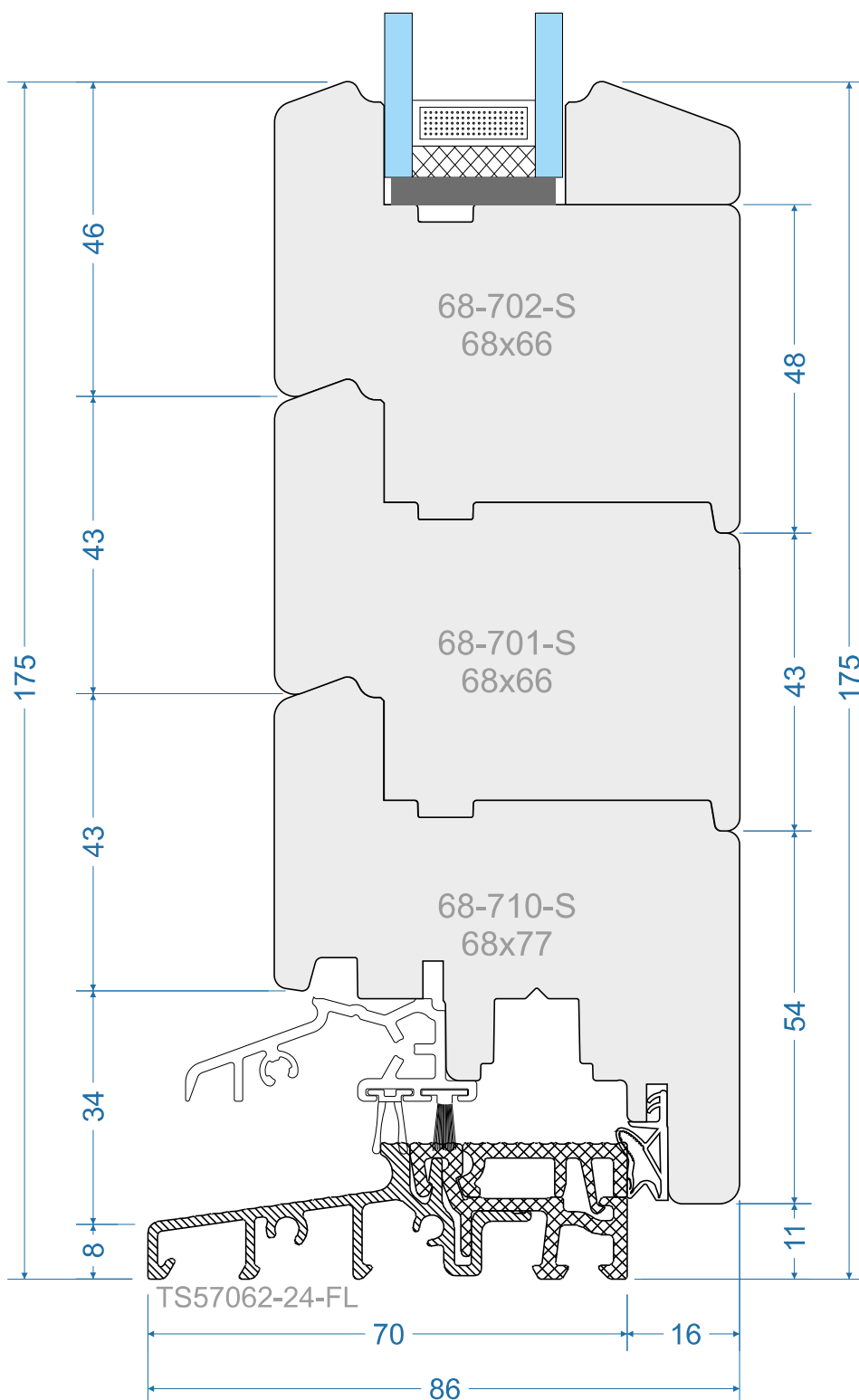

-  Wyrównanie do „Próg aluminiowy + skrzydło 77mm + cokół 66mm”
-  Alignment to „Aluminum threshold + sash 77mm + plinth 66mm”
-  Alignement sur le „Seuil en aluminium + châssis 77mm + socle 66mm”
-  Allineamento alla „Soglia in alluminio + anta 77mm + zoccolo 66mm”
-  Ausrichtung an der „Aluminiumschwelle + Flügel 77mm + Sockel 66mm”

STL-03-68-S-0028

out

in



-  Próg aluminiowy + skrzydło 77mm + cokół 66mm + cokół 66mm
-  Aluminum threshold + sash 77mm + plinth 66mm + plinth 66mm
-  Seuil en aluminium + châssis 77mm + socle 66mm + socle 66mm
-  Soglia in alluminio + anta 77mm + zoccolo 66mm + zoccolo 66mm
-  Aluminiumschwelle + Flügel 77mm + Sockel 66mm + Sockel 66mm

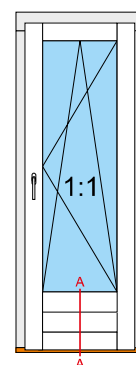

STL-03-68-S-0029

Style 02 68mm „S”

Style 02 68mm „R”

Style 03 68mm „S”

Style 03 68mm „R”





French 01

French 02

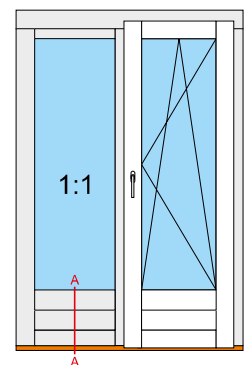
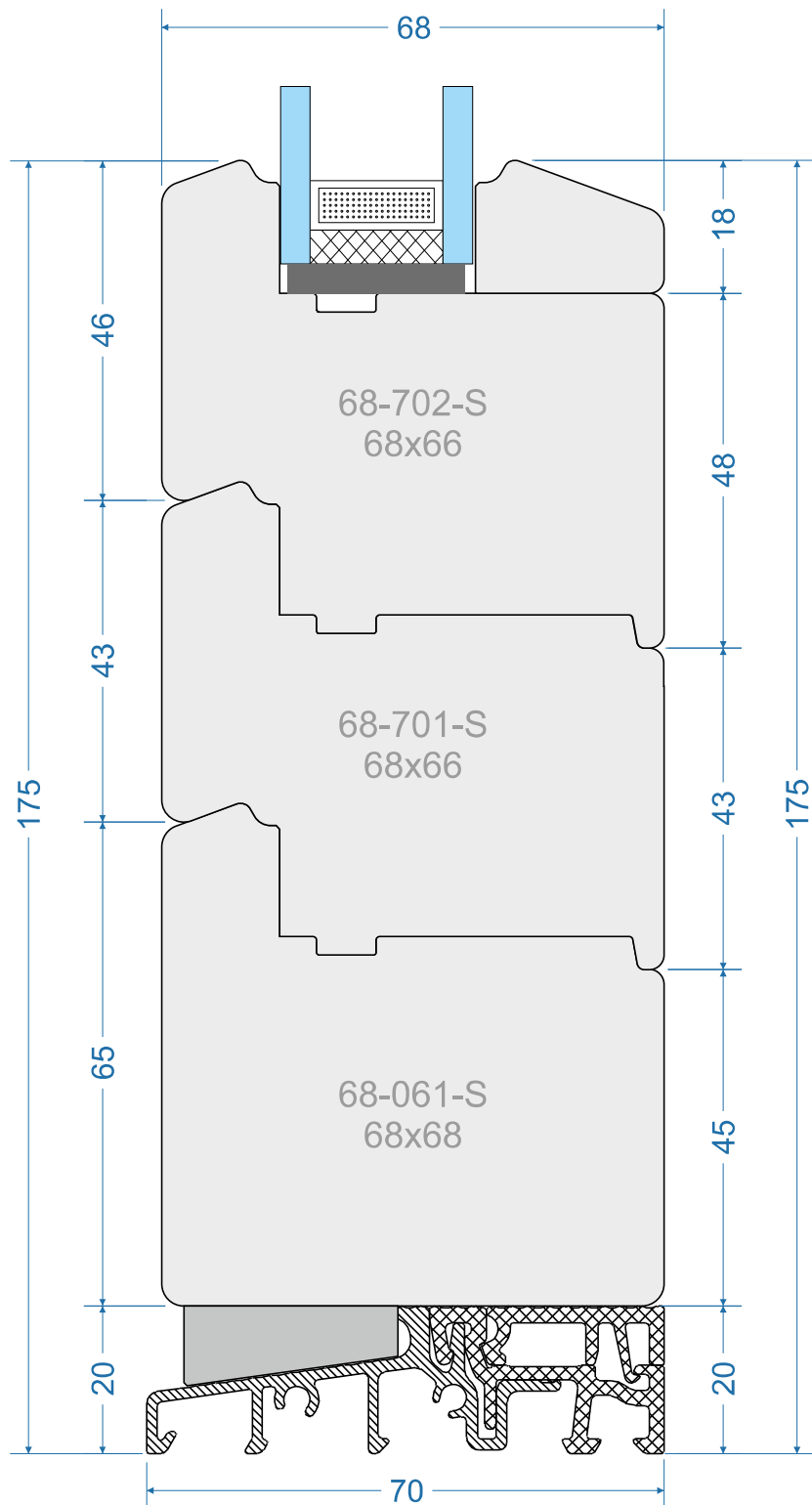
out

in







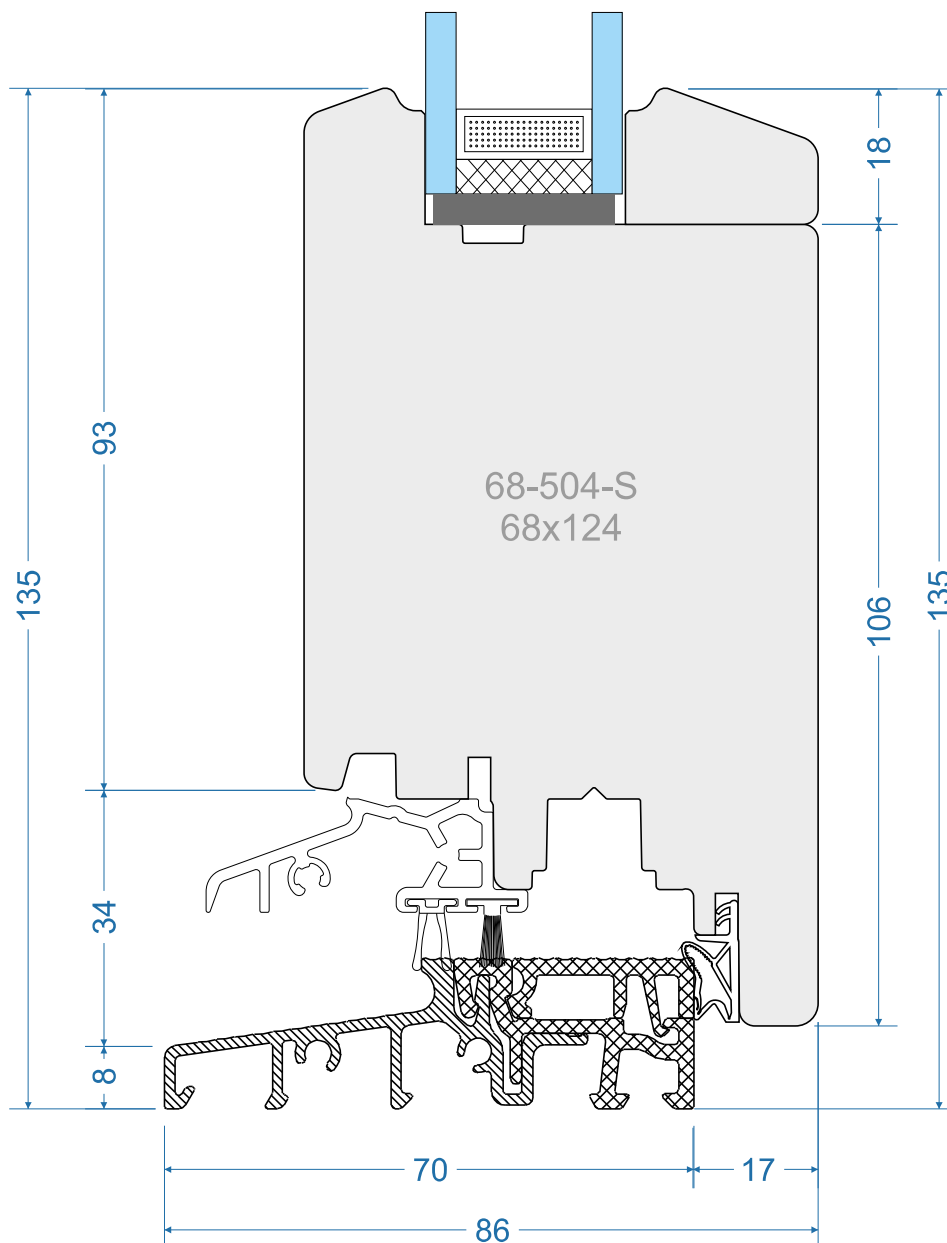

-  Wyrównanie do „Próg aluminiowy + skrzydło 77mm + cokół 66mm + cokół 66mm”
-  Alignment to „Aluminum threshold + sash 77mm + plinth 66mm + plinth 66mm”
-  Alignement sur le „Seuil en aluminium + châssis 77mm + socle 66mm + socle 66mm”
-  Allineamento alla „Soglia in alluminio + anta 77mm + zoccolo 66mm + zoccolo 66mm”
-  Ausrichtung an der „Aluminiumschwelle + Flügel 77mm + Sockel 66mm + Sockel 66mm”

STL-03-68-S-0030

out

in



-  Próg aluminiowy + skrzydło 124mm
-  Aluminum threshold + sash 124mm
-  Seuil en aluminium + ouvrant 124mm
-  Soglia in alluminio + anta 124mm
-  Aluminiumschwelle + Flügel 124mm

STL-03-68-S-0031

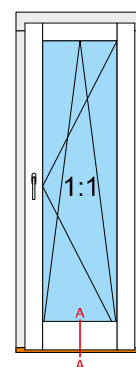

Style 02 68mm „S”

Style 02 68mm „R”

Style 03 68mm „S”

Style 03 68mm „R”





French 01

French 02

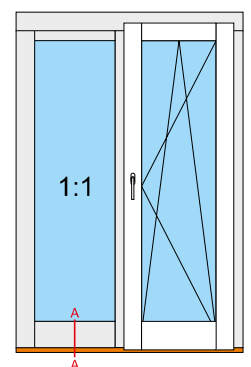
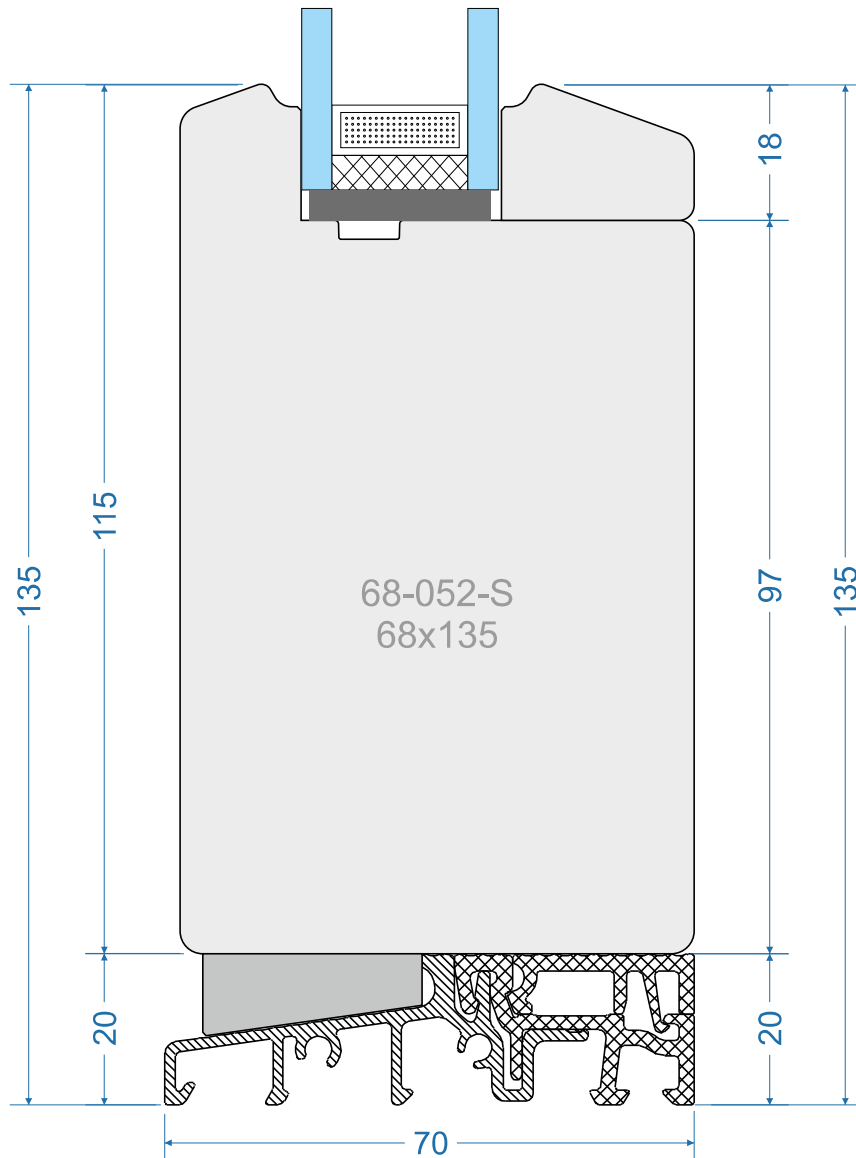
out

in







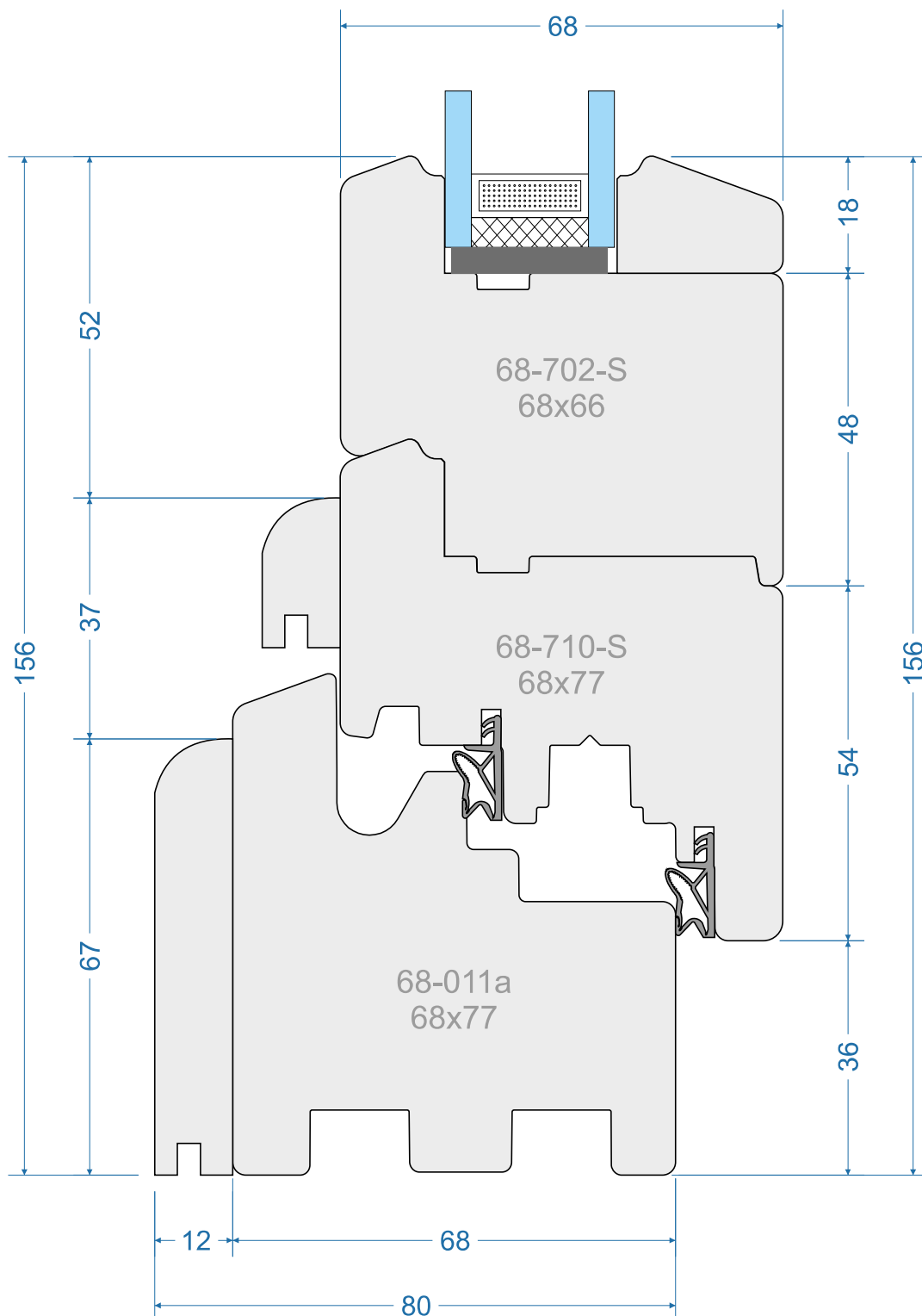

-  Wyrównanie do „Próg aluminiowy + skrzydło 124mm”
-  Alignment to „Aluminum threshold + sash 124mm”
-  Alignement sur le „Seuil en aluminium + ouvrant 124mm”
-  Allineamento alla „Soglia in alluminio + anta 124mm”
-  Ausrichtung an der „Aluminiumschwelle + Flügel 124mm”

STL-03-68-S-0032

out

in



-  Rama + skrzydło 77mm + cokół 66mm
-  Frame + sash 77mm + plinth 66mm
-  Cadre + châssis 77mm + socle 66mm
-  Telaio + anta 77mm + zoccolo 66mm
-  Rahmen + Flügel 77mm + Sockel 66mm

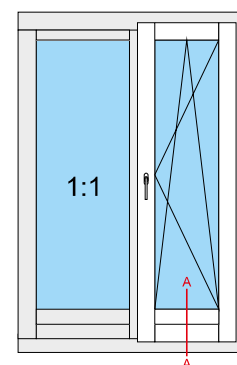

STL-03-68-S-0033

Style 02 68mm „S”

Style 02 68mm „R”

Style 03 68mm „S”

Style 03 68mm „R”

French 01

French 02

Style 02 68mm „S”

Style 02 68mm „R”

Style 03 68mm „S”

Style 03 68mm „R”





French 01

French 02

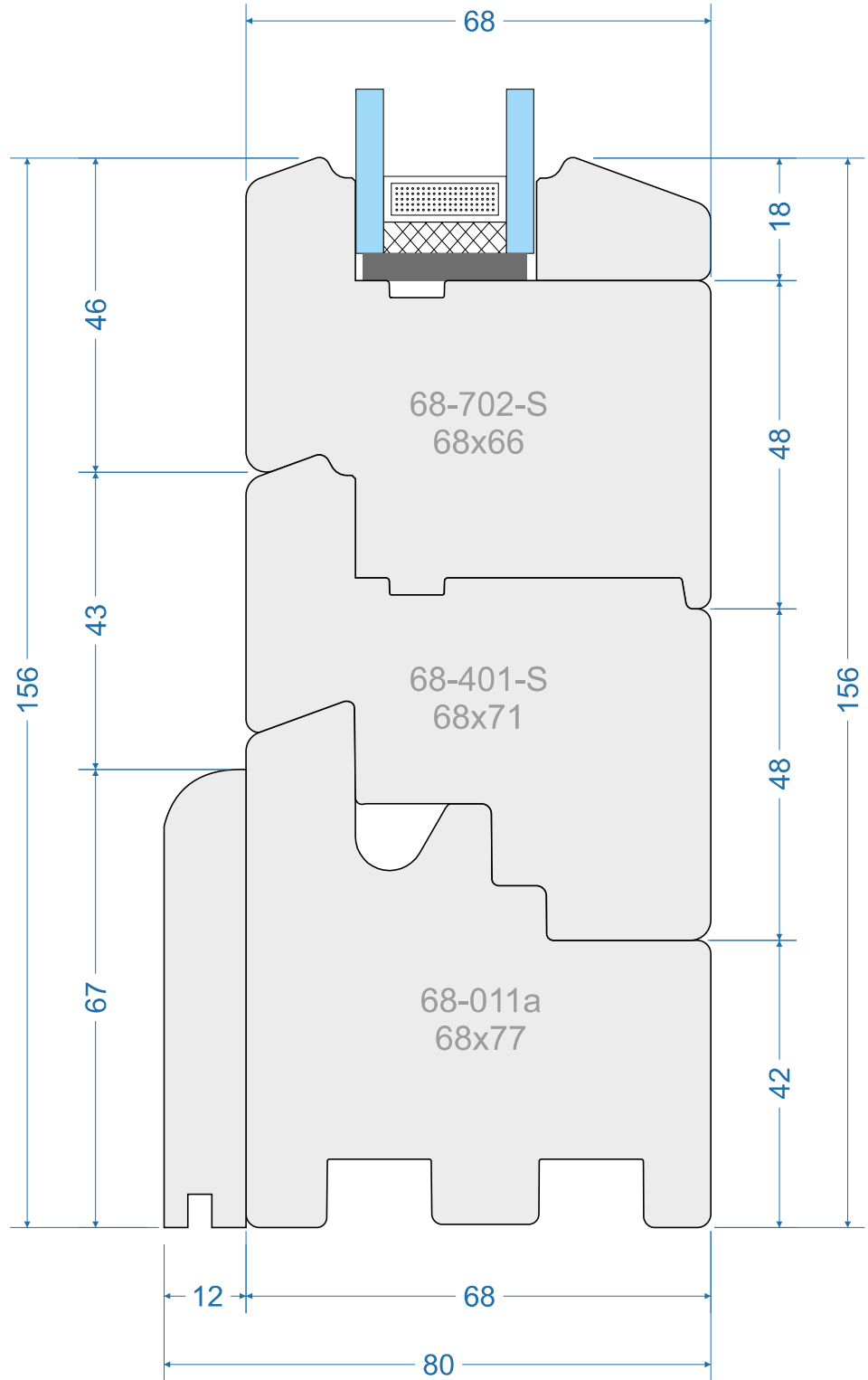
out

in



-  Wyrównanie do „Rama + skrzydło 77mm + cokół 66mm”
-  Alignment to „Frame + sash 77mm + plinth 66mm”
-  Aligneamento sur le „Cadre + châssis 77mm + socle 66mm”
-  Allineamento alla „Telaio + anta 77mm + zoccolo 66mm”
-  Ausrichtung an der „Rahmen + Flügel 77mm + Sockel 66mm”

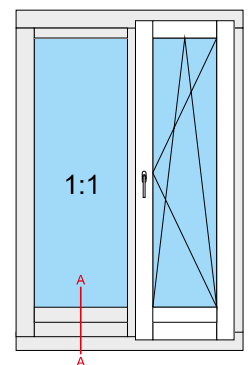

out

in

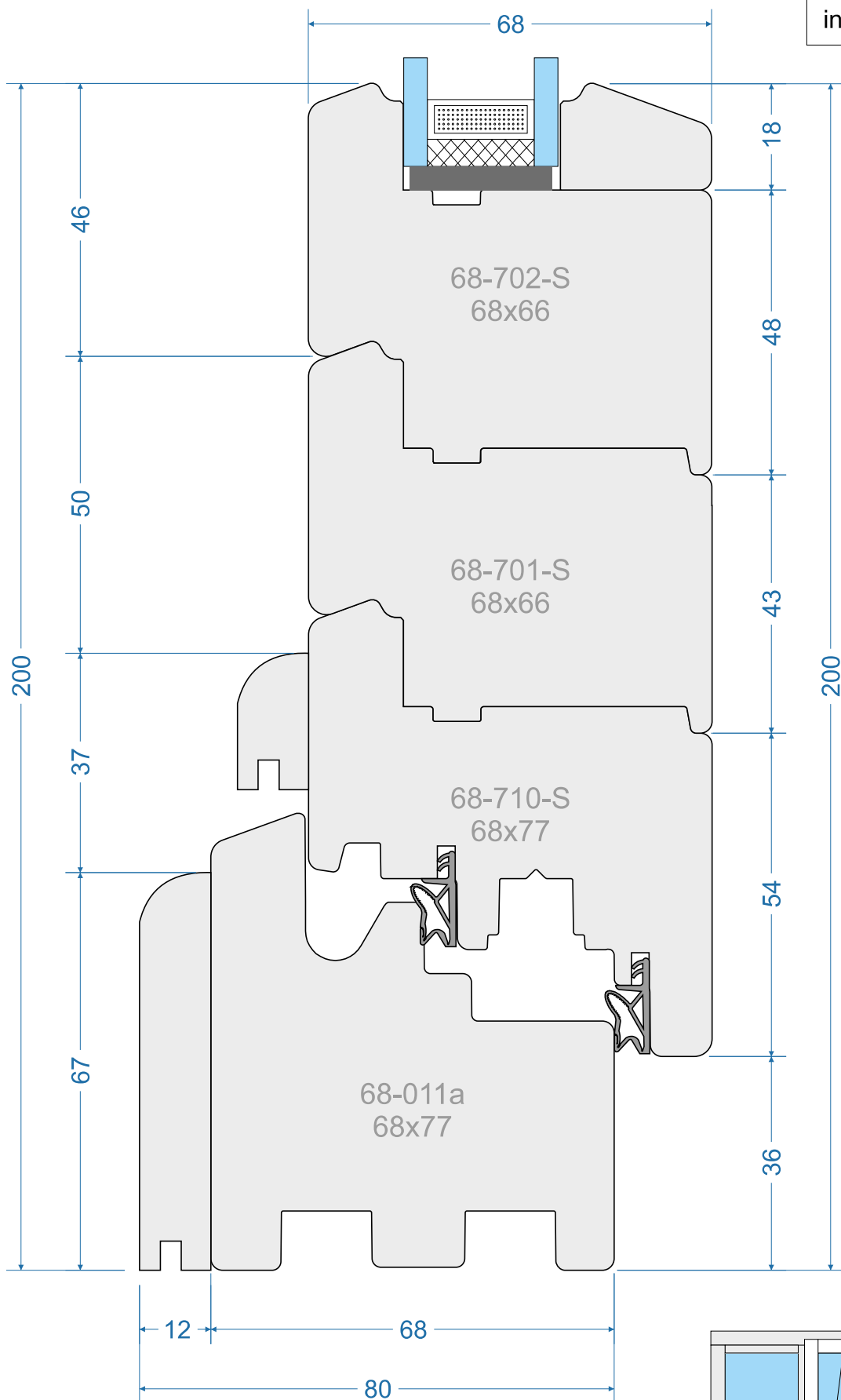

-  Rama + skrzydło 77mm + cokół 66mm + cokół 66mm
-  Frame + sash 77mm + plinth 66mm + plinth 66mm
-  Cadre + châssis 77mm + socle 66mm + socle 66mm
-  Telaio + anta 77mm + zoccolo 66mm + zoccolo 66mm
-  Rahmen + Flügel 77mm + Sockel 66mm + Sockel 66mm

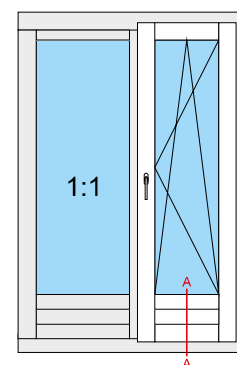

STL-03-68-S-0035

Style 02 68mm „S”

Style 02 68mm „R”

Style 03 68mm „S”

Style 03 68mm „R”





French 01

French 02

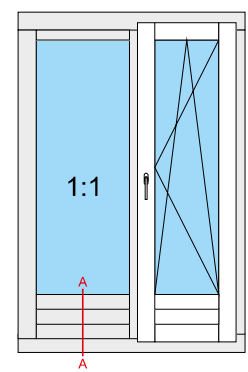
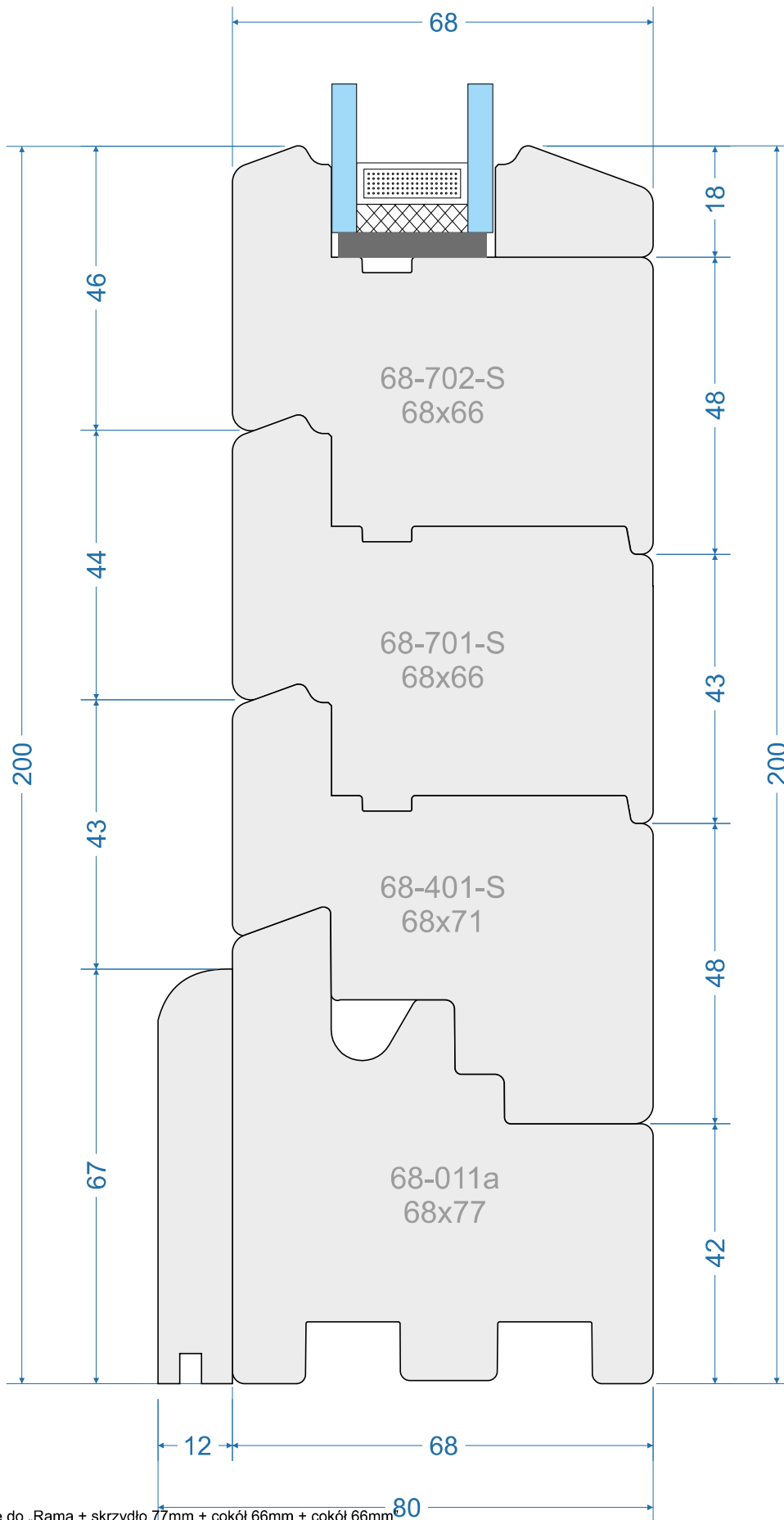



out

in

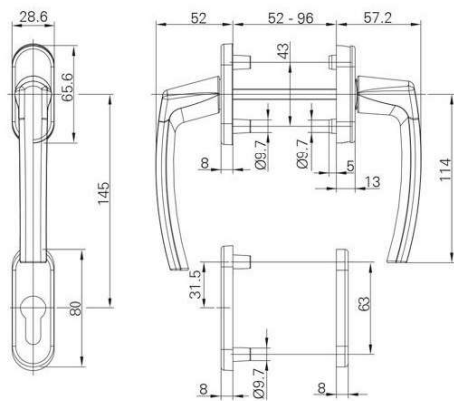
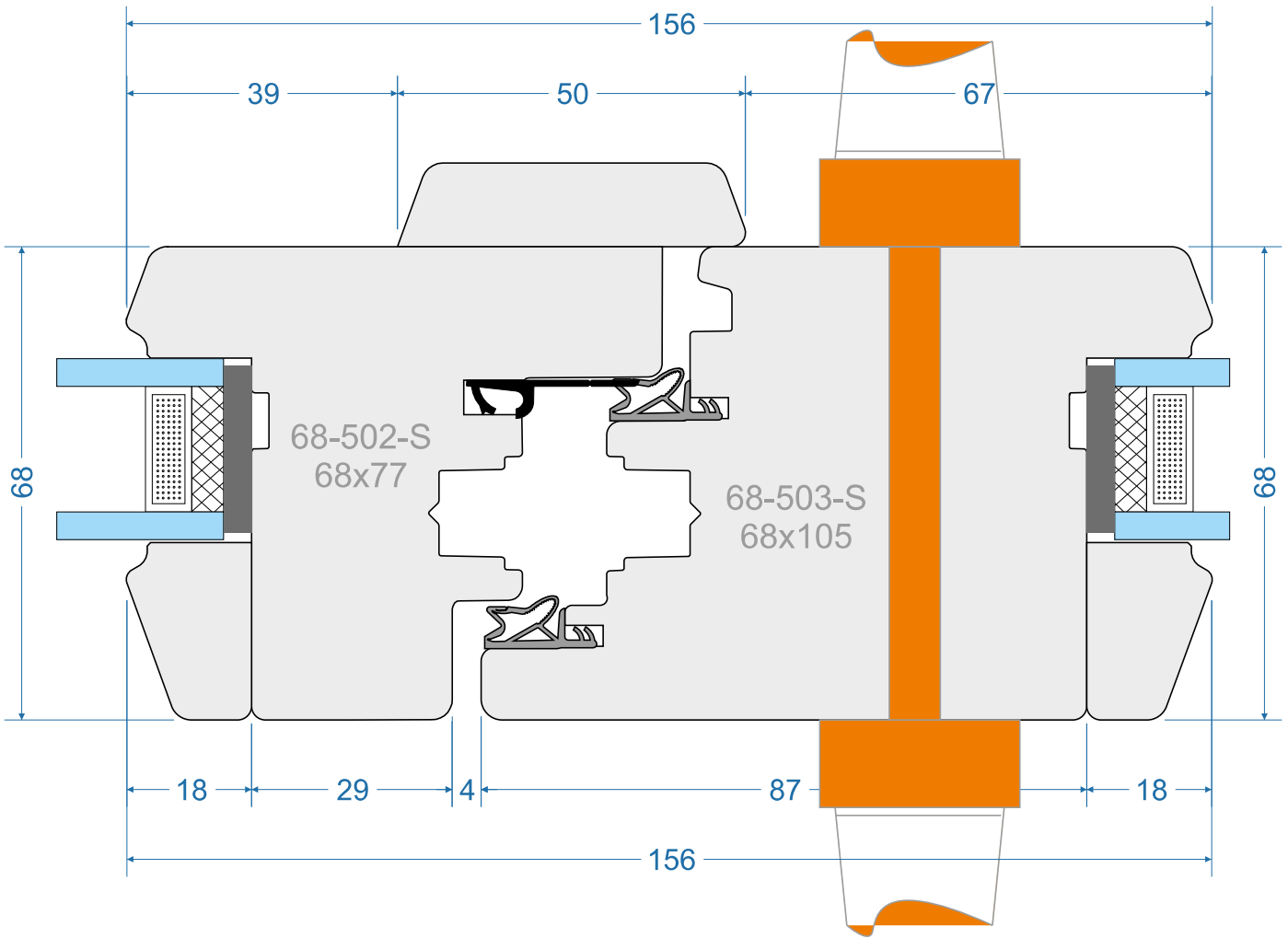

-  Wyrównanie do „Rama + skrzydło 77mm + cokół 66mm + cokół 66mm”
-  Alignment to „Frame + sash 77mm + plinth 66mm + plinth 66mm”
-  Aligement sur le „Cadre + châssis 77mm + socle 66mm + socle 66mm”
-  Allineamento alla „Telaio + anta 77mm + zoccolo 66mm + zoccolo 66mm”
-  Ausrichtung an der „Rahmen + Flügel 77mm + Sockel 66mm + Sockel 66mm”



-  Dwustronna klamka okienna
-  Double side window type handle
-  Poignée de fenêtre double face
-  Maniglia bifacciale per finestre
-  Doppelseitiger Fenster Griff

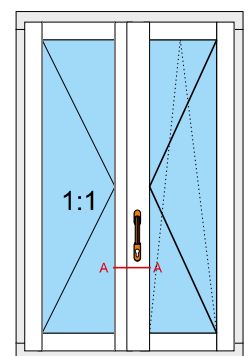

STL-03-68-S-0037

Style 02 68mm „S”

Style 02 68mm „R”

Style 03 68mm „S”

Style 03 68mm „R”

French 01

French 02

Style 02 68mm „S”

Style 02 68mm „R”

Style 03 68mm „S”

Style 03 68mm „R”

French 01

French 02

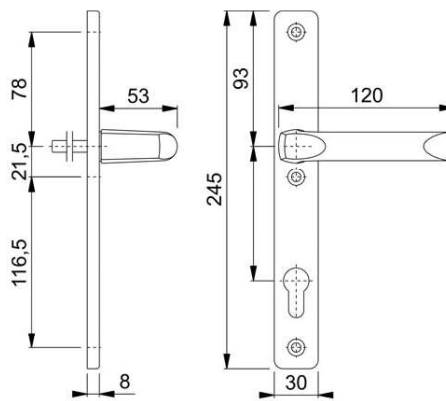
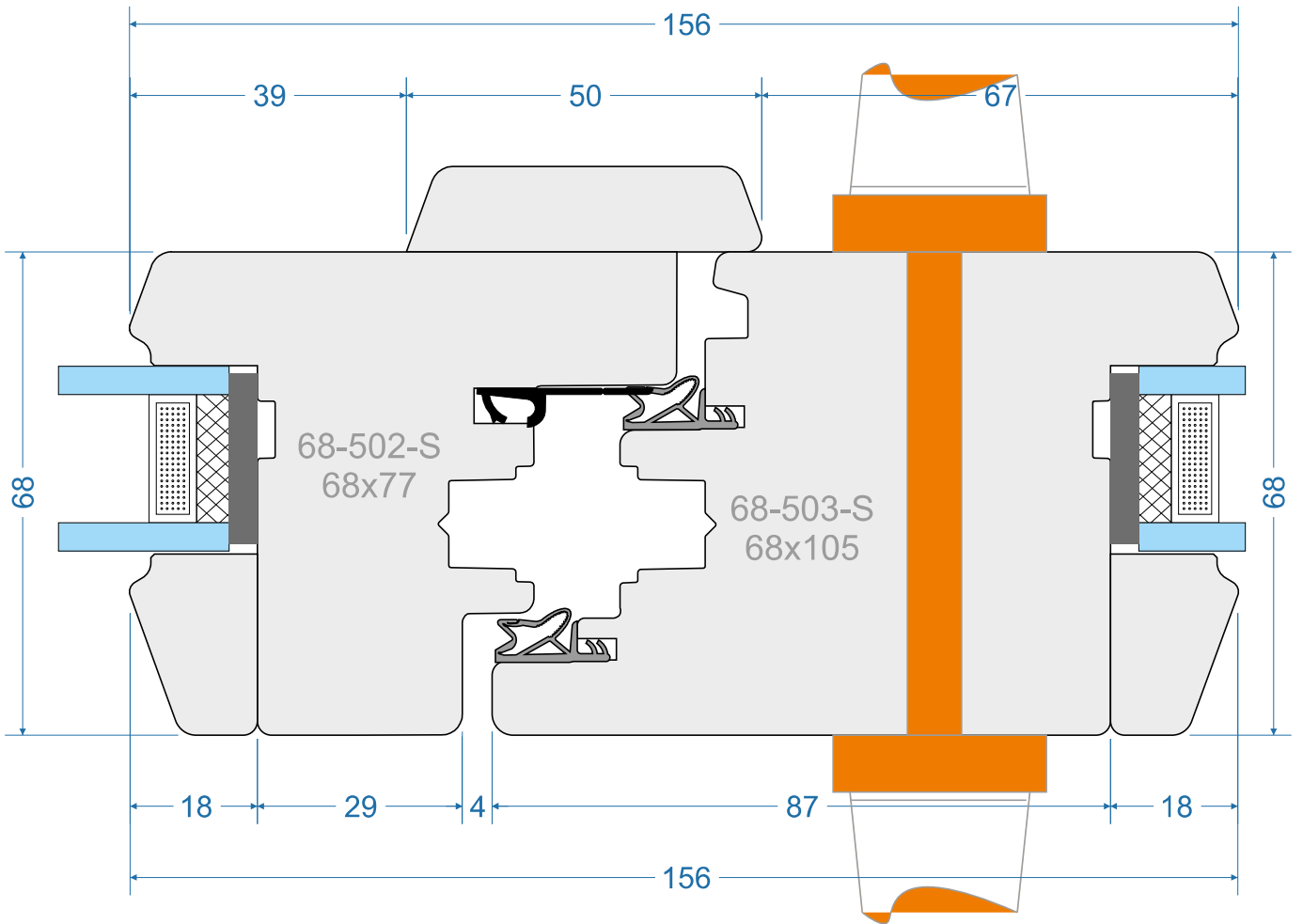



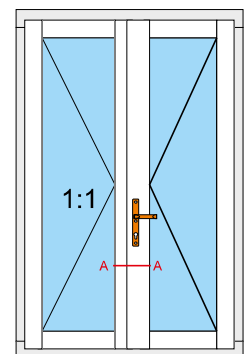



- Dwustronna klamka drzewiowa
- Double side door type handle
- Poignée de Porte Fenêtre double face
- Maniglia bifacciale per porte finestre
- Doppelseitiger Tür Griff

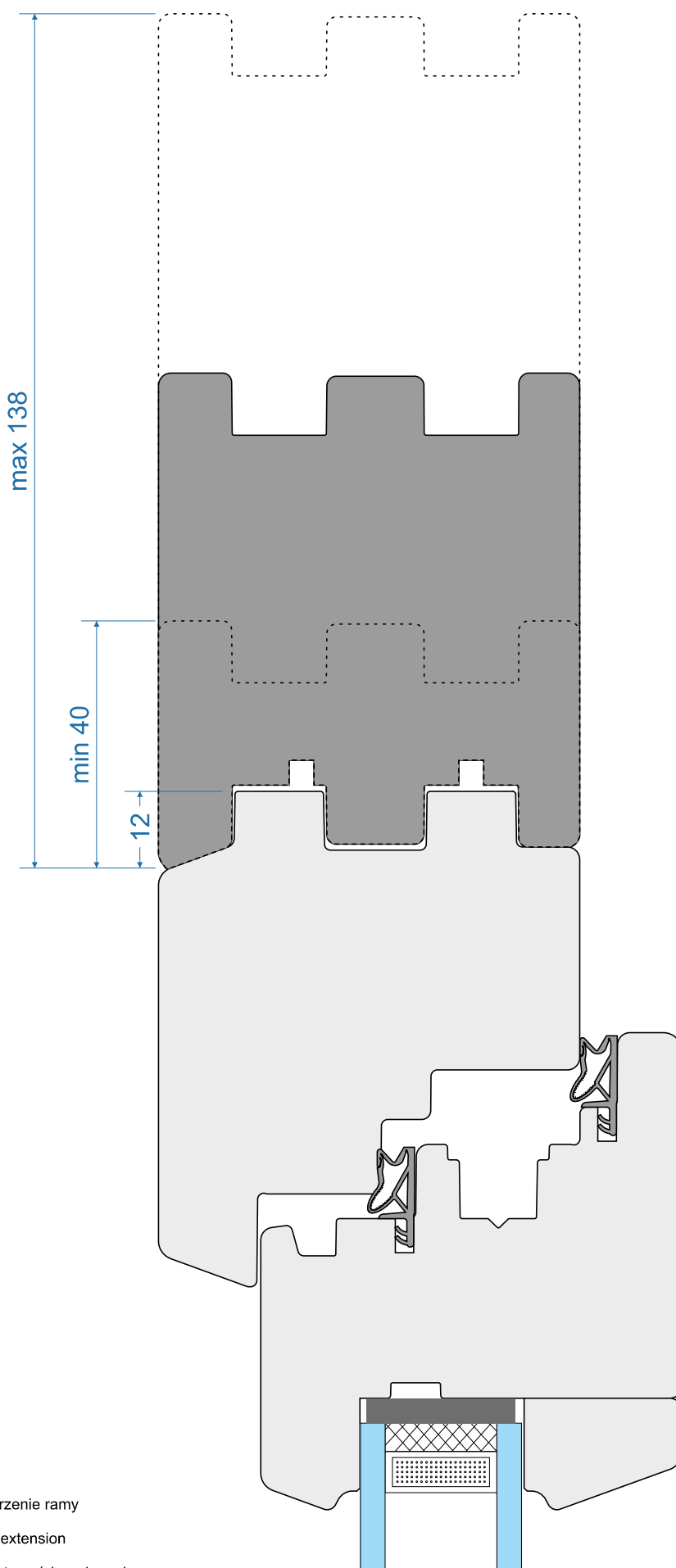

out

in



-  Górne poszerzenie ramy
-  Upper frame extension
-  Élargissement supérieur du cadre
-  Estensione del telaio superiore
-  Obere Rahmenverbreitung

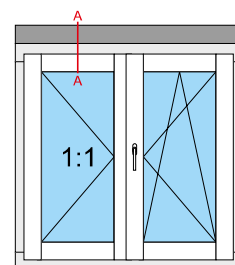

STL-03-68-S-0039

Style 02 68mm „S”

Style 02 68mm „R”

Style 03 68mm „S”

Style 03 68mm „R”

French 01

French 02

out

Style 02 68mm „S”

Style 02 68mm „R”

Style 03 68mm „S”



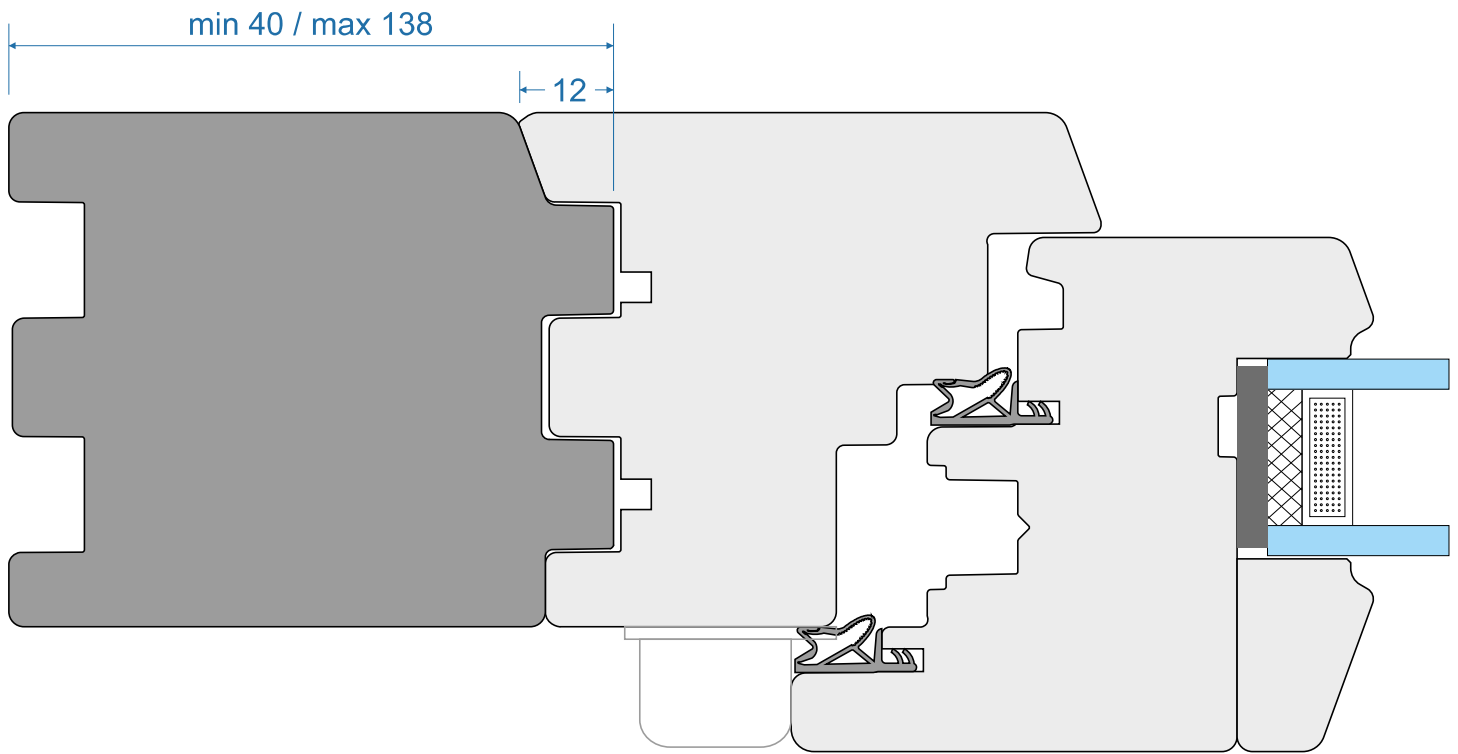

Style 03 68mm „R”

French 01

French 02



in



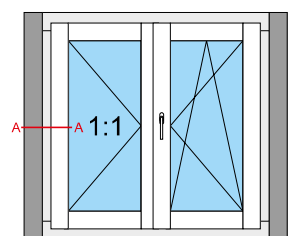

-  Boczne poszerzenie ramy
-  Side frame extension
-  Élargissement latéral du cadre
-  Estensione del telaio laterale
-  Seitliche Rahmenverbreiterung

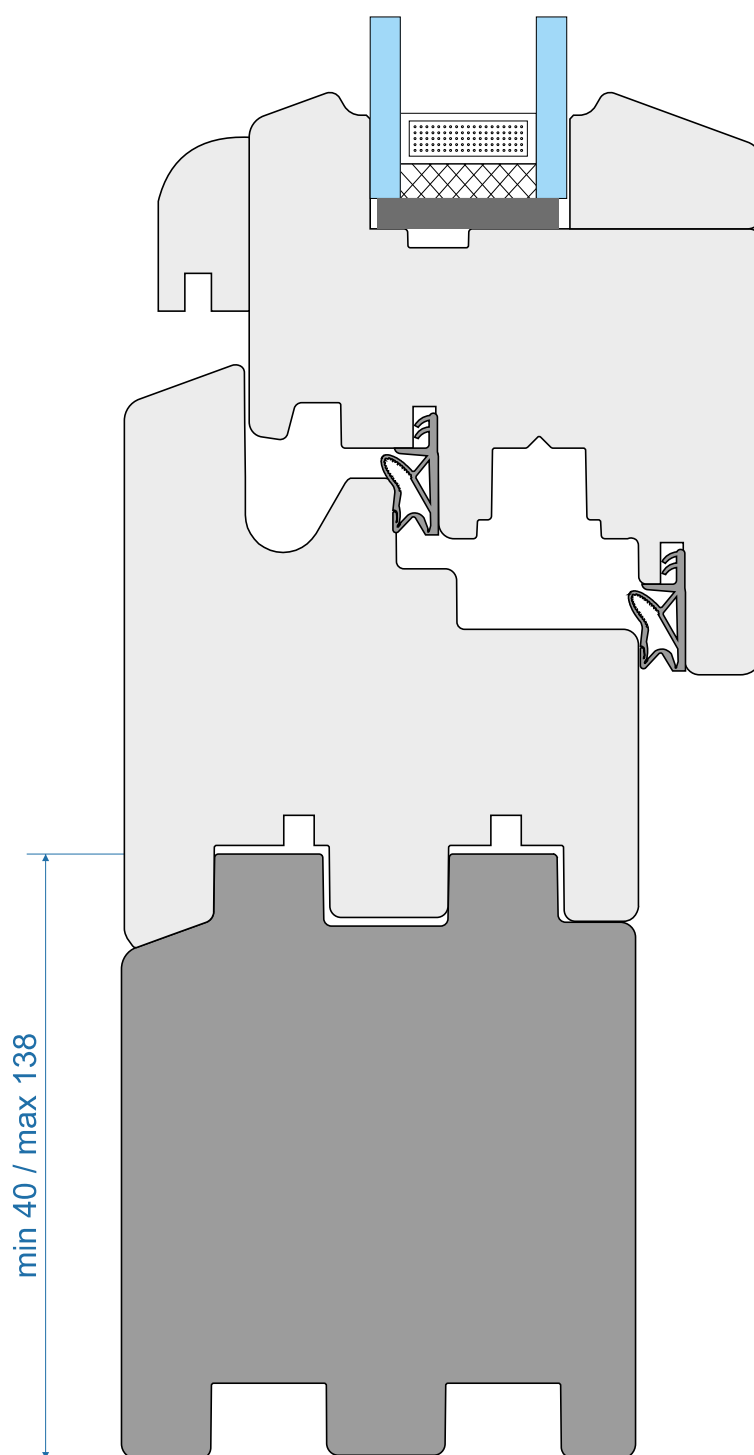

out

in



-  Dolne poszerzenie ramy
-  Lower frame extension
-  Élargissement inférieure du cadre
-  Estensione del telaio inferiore
-  Untere Rahmenverbreitung

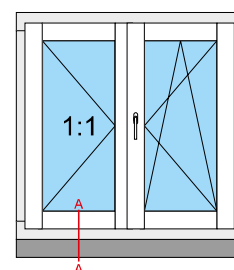

STL-03-68-S-0041

Style 02 68mm „S”

Style 02 68mm „R”

Style 03 68mm „S”

Style 03 68mm „R”

French 01

French 02

Style 02 68mm „S”

Style 02 68mm „R”

Style 03 68mm „S”

Style 03 68mm „R”





French 01

French 02

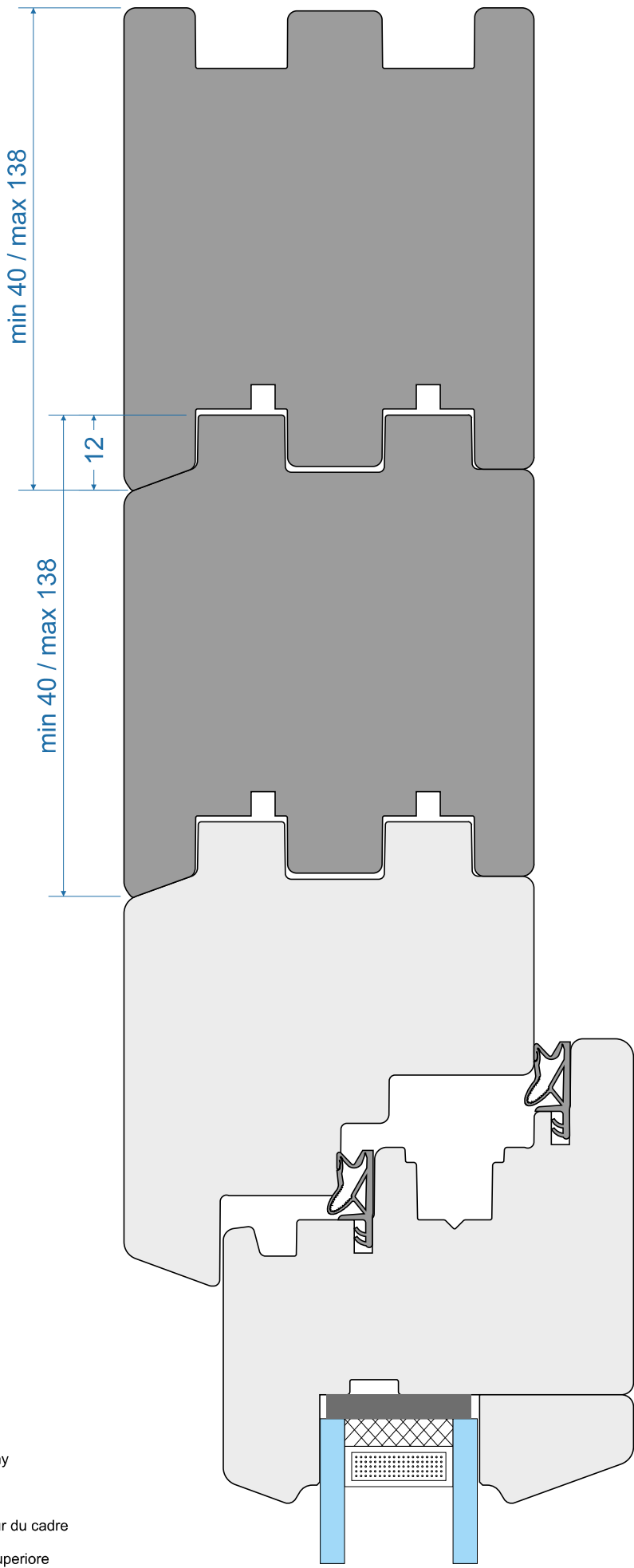
out

in



-  Górne poszerzenie ramy
-  Upper frame extension
-  Élargissement supérieur du cadre
-  Estensione del telaio superiore
-  Obere Rahmenverbreitung

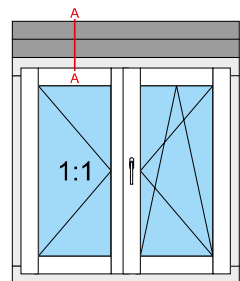



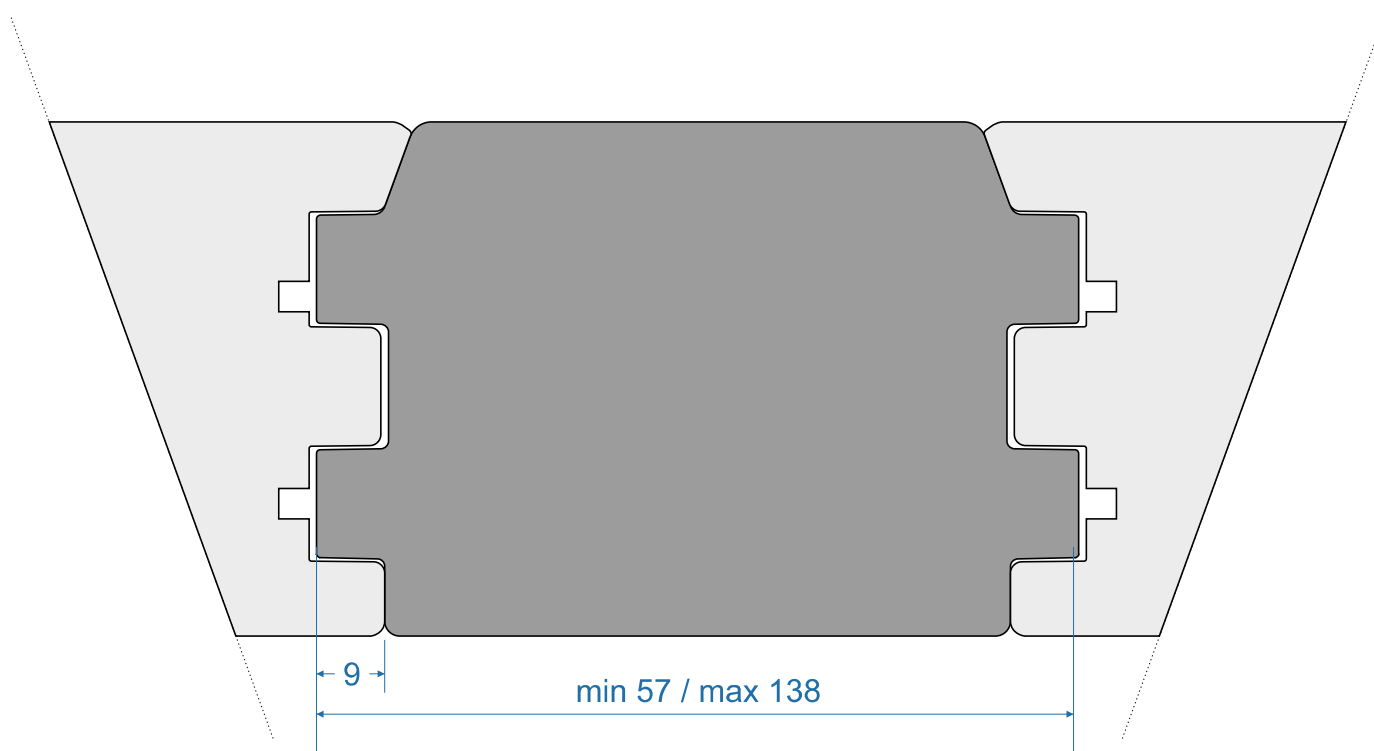

STL-03-68-S-0042

out

in



-  Środkowe poszerzenie ramy
-  Middle frame extension
-  Montant d'assemblage
-  Montante di accoppiamento
-  Zentral Rahmenverbreiterung

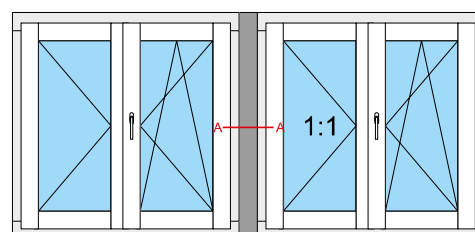

STL-03-68-S-0043

Style 02 68mm „S”

Style 02 68mm „R”

Style 03 68mm „S”

Style 03 68mm „R”

French 01

French 02

out

Style 02 68mm „S”

Style 02 68mm „R”

Style 03 68mm „S”



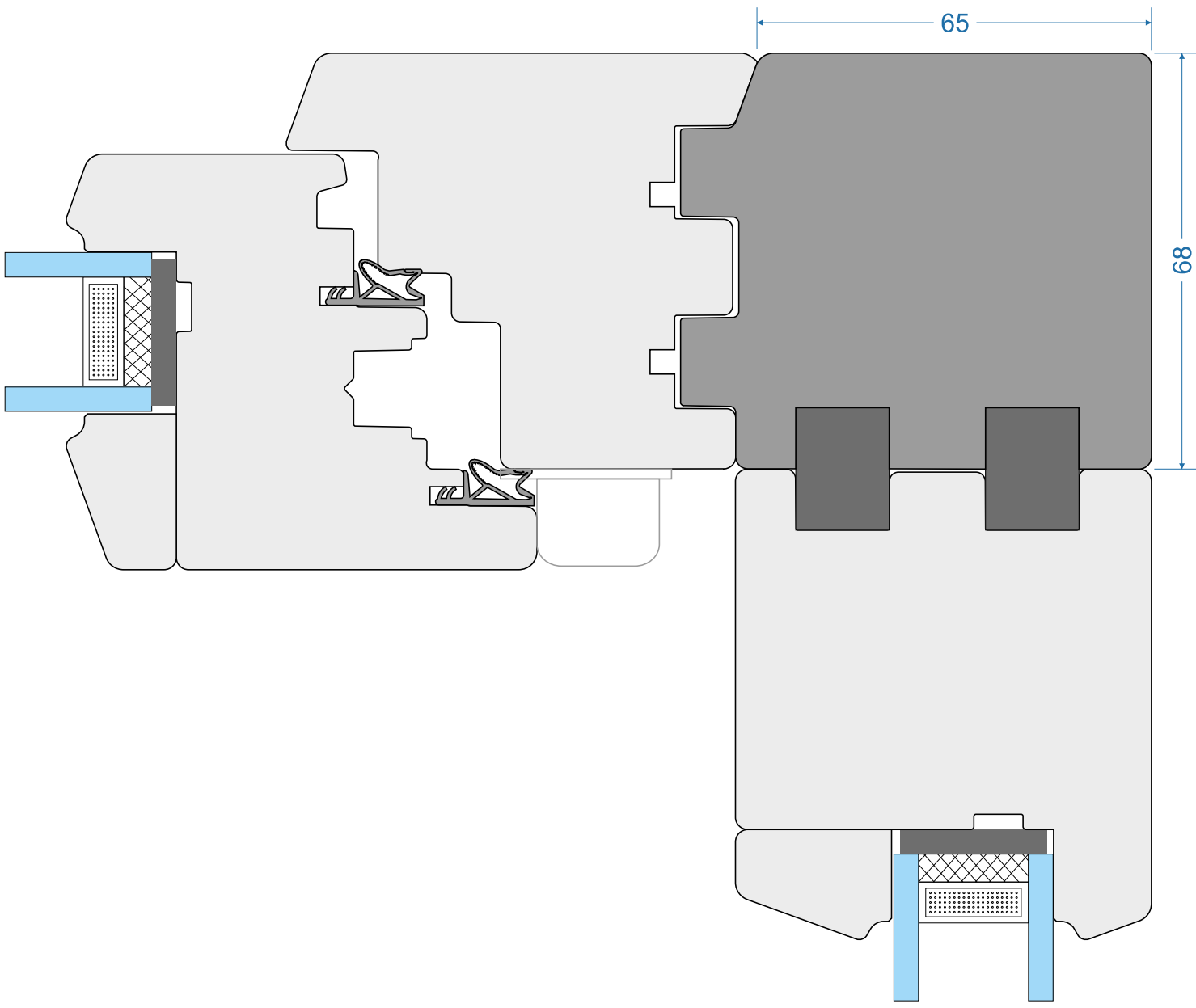

Style 03 68mm „R”

French 01

French 02



in

-  Łącznik 90 stopni
-  90 degree corner connecting post
-  Montant d'assemblage à 90 degrés
-  Montante di accoppiamento 90 gradi
-  90-Grad-Eckpfosten

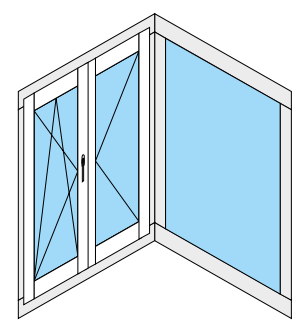

out

in

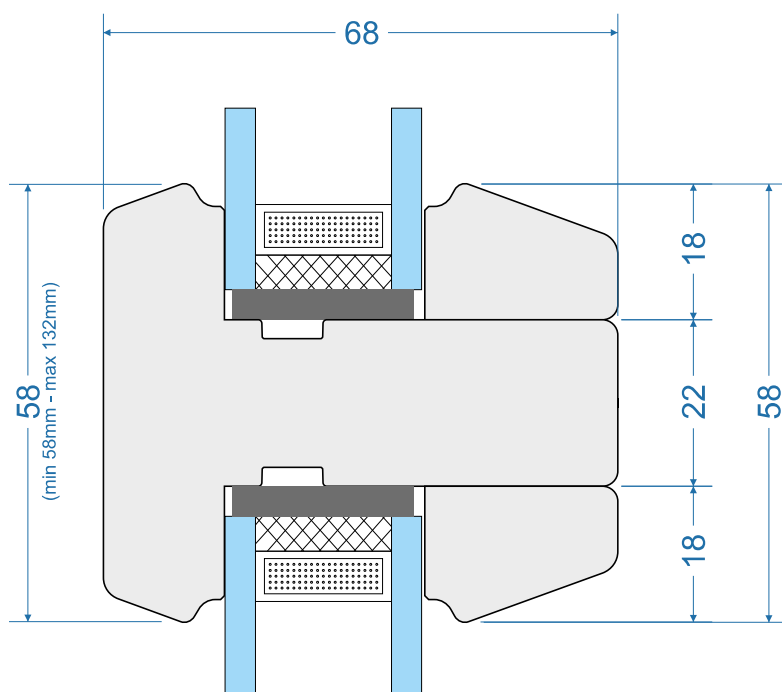

-  Szpros konstrukcyjny
-  Construction type muntin
-  De vrais crossillon
-  Traverso
-  Glasteilende Sprosse

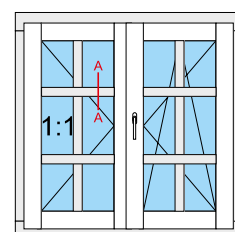

STL-03-68-S-0045

Style 02 68mm „S”

Style 02 68mm „R”

Style 03 68mm „S”

Style 03 68mm „R”

French 01

French 02

out

in

W-01

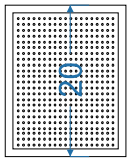
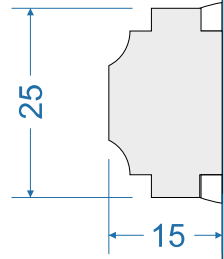

W-02

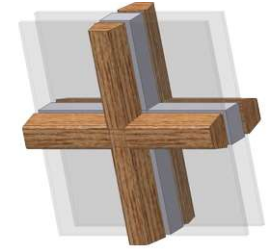
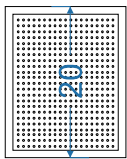
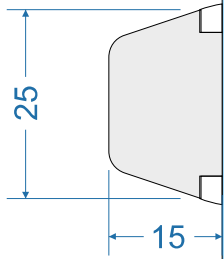

W-03

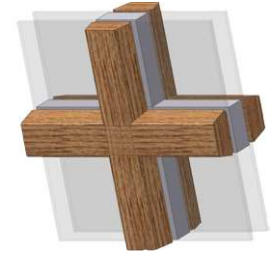
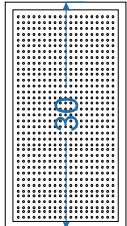
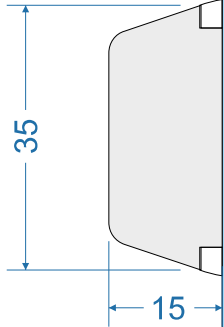



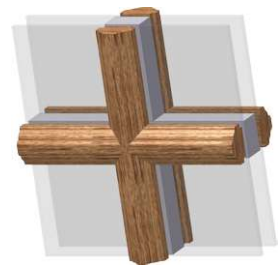
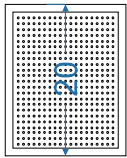
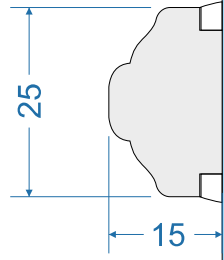

W-04

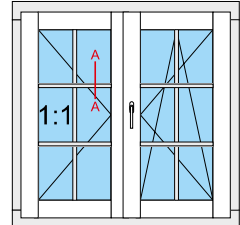
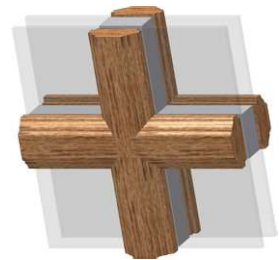
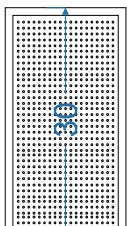
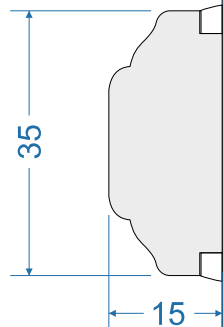

W-05



-  Szpros wideński (Duplex)
-  Vienna muntin (Duplex)
-  Petits bois Viennoise (Duplex)
-  Traverse incollate Viennese (Duplex)
-  Wiener Sprosse (Duplex)

out

in

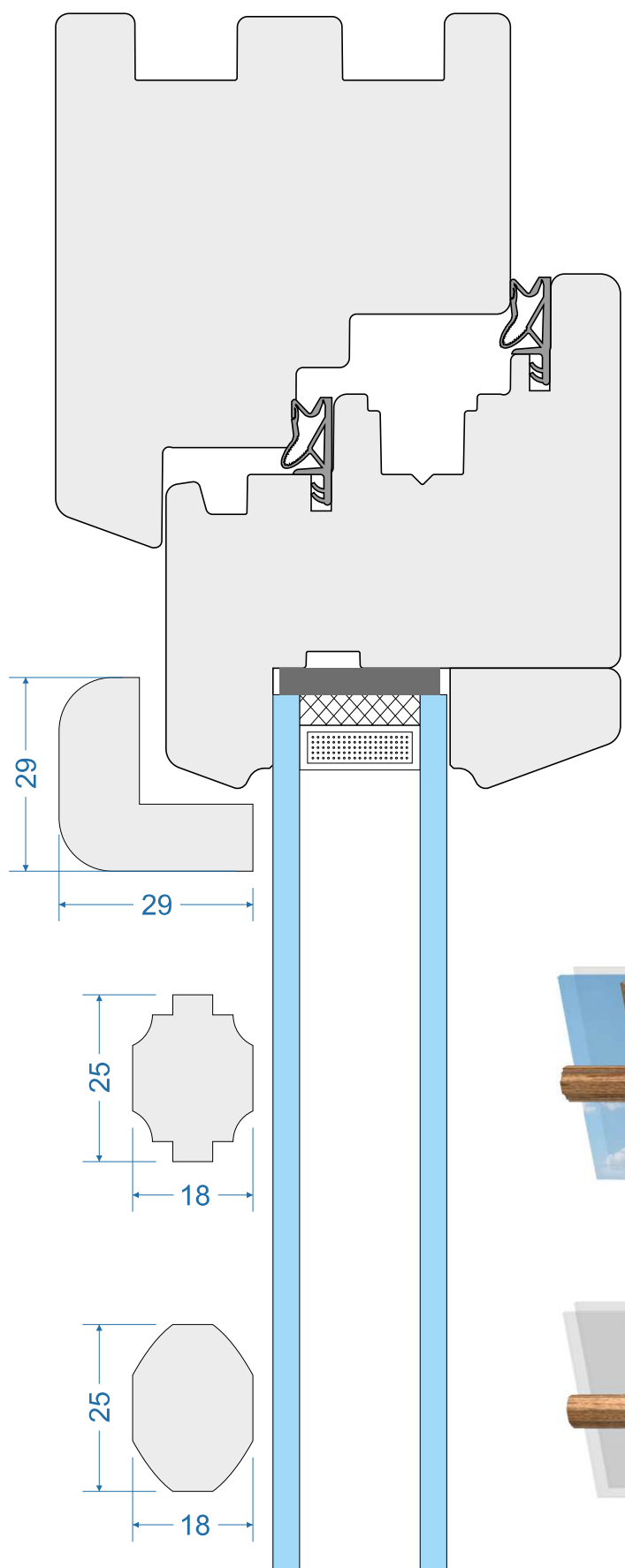

P-01

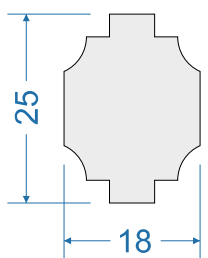

P-02

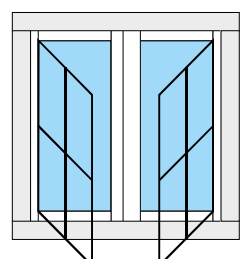
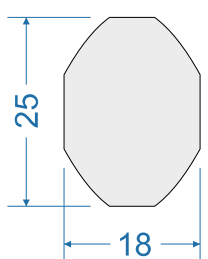

-  Szpros otwierany
-  Openable muntin
-  Croisillon ouvrable
-  Montatura apribile
-  Aufklappbare Sprossen

STL-03-68-S-0047

Style 02 68mm „S”

Style 02 68mm „R”

Style 03 68mm „S”

Style 03 68mm „R”

French 01

French 02