



**VIDAWO**

Windows | Doors | Shutters  
MANUFACTURER

1/2023

# Standard 68mm „R”

STD-68-R



Standard 68mm „S”

Standard 68mm „R”

Classik 68mm „S”

Classik 68mm „R”

Style 01 68mm „S”

Style 01 68mm „R”

STD-68-R-001

out

in

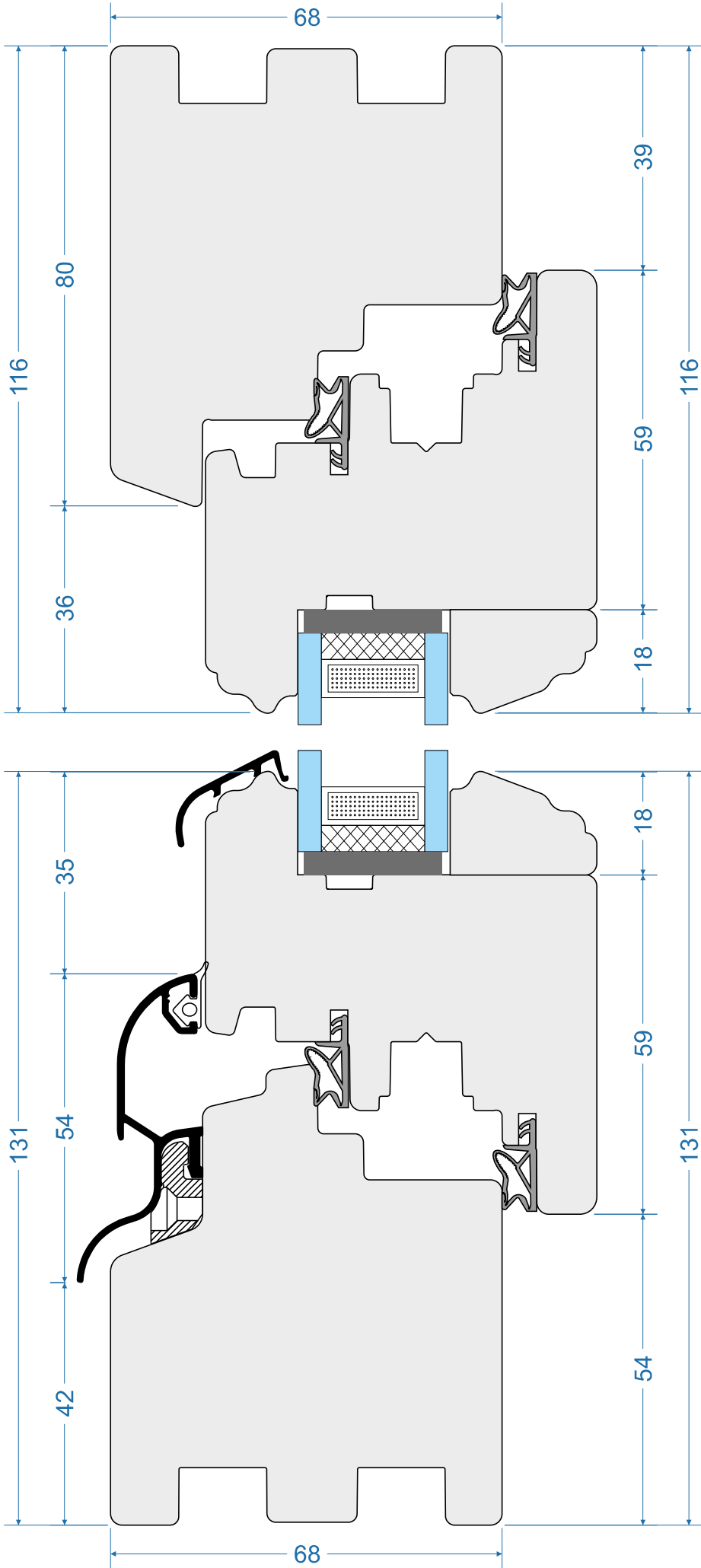

STD-68-R-002

Standard 68mm „S“

Standard 68mm „R“

Classik 68mm „S“

Classik 68mm „R“





Style 01 68mm „S“

Style 01 68mm „R“

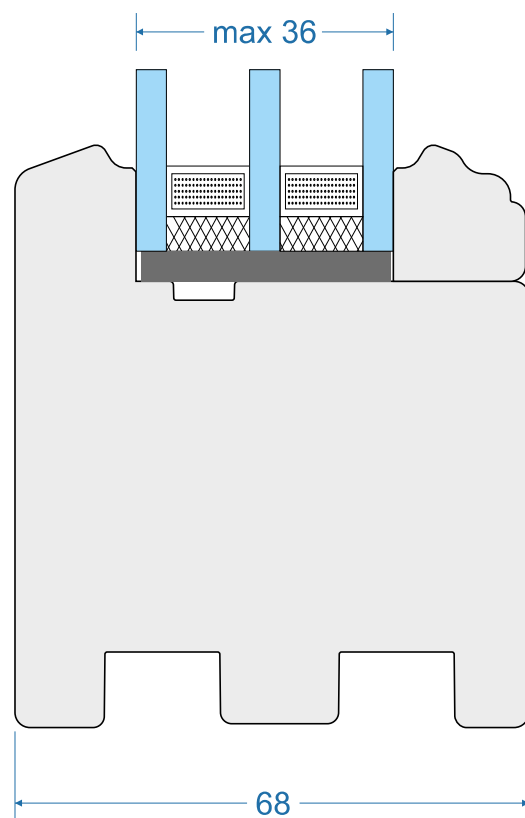
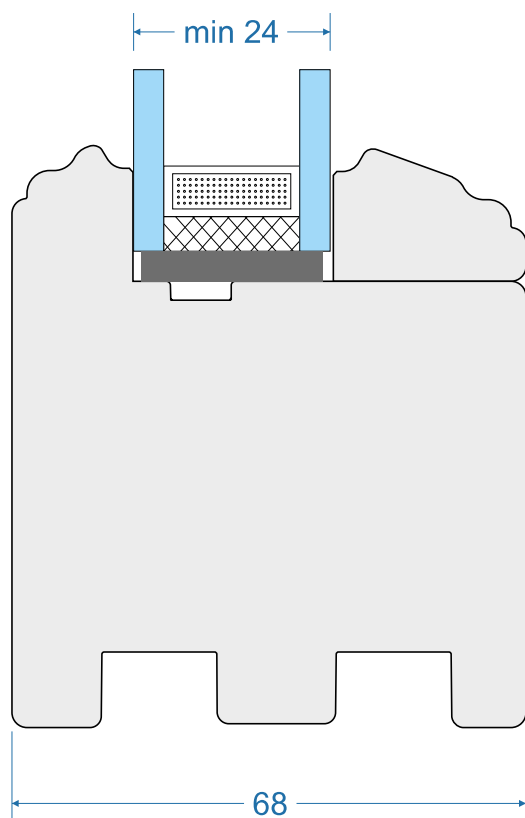
out

in



-  Minimalna / maksymalna grubość pakietu szybowego
-  Minimum / maximum glass thickness
-  Épaisseur minimale / maximale du verre
-  Spessore minimo/massimo del vetro
-  Minimale / maximale Stärke des verglasungs paketes

out



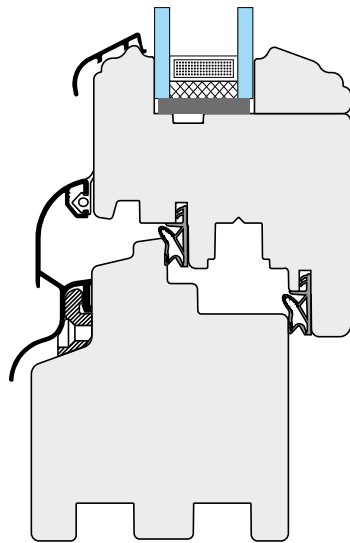

in

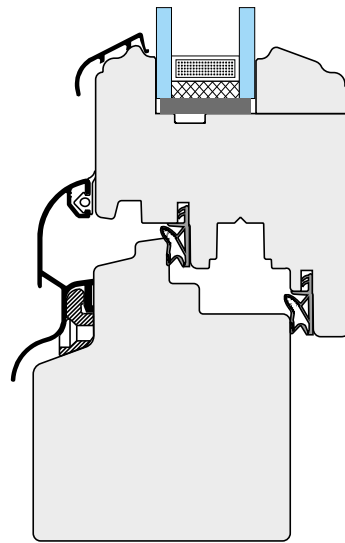

68 DN



R3

-  Stabdardowe frezowanie ramy
-  Standard frame finish
-  Finition de cadre standard
-  Finitura telaio standard
-  Standard-Rahmenausführung

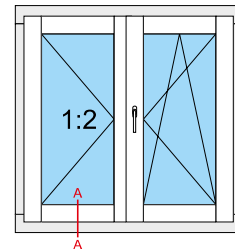

out

in

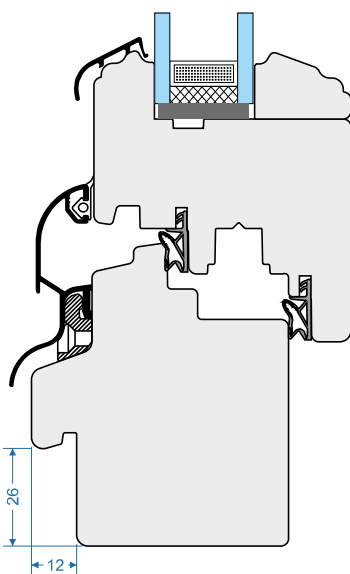



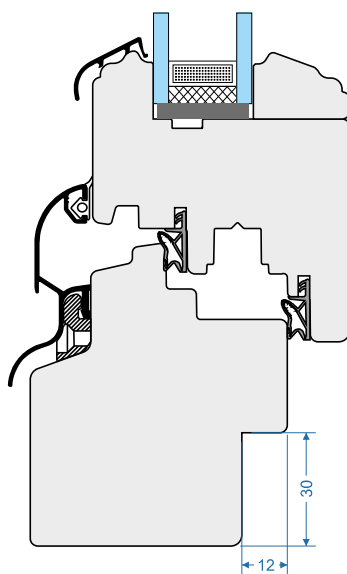

EXT 12x26

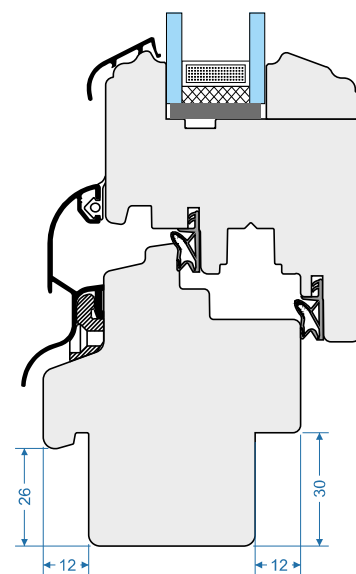

INT 12x30



EXT 12x26  
INT 12x30



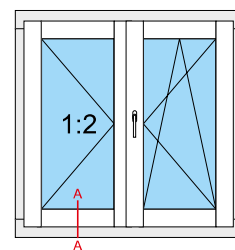

-  Frezy pod parapety
-  Groove for the window sill
-  Rainure pour le rebord de la fenêtre
-  Scanalatura per il davanzale della finestra
-  Nut für die Fensterbank

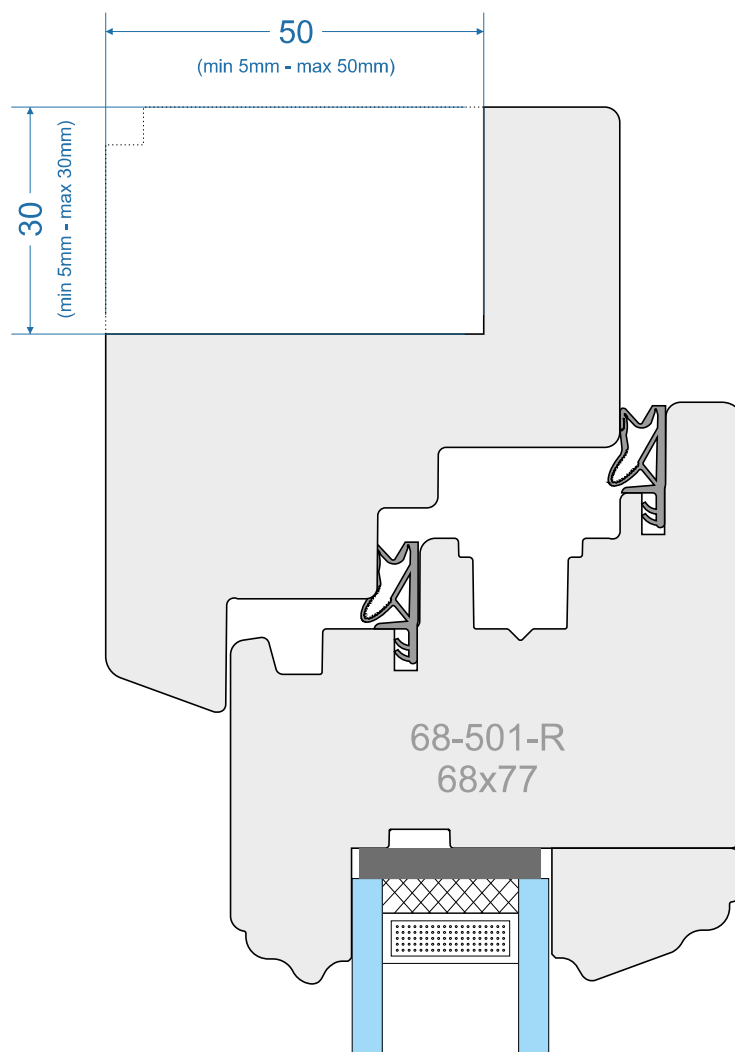

out

in



-  Frez renowacyjny od zewnątrz
-  Renovation groove from the outside
-  Rainure de rénovation à l'extérieur
-  Scanalatura di ristrutturazione all'esterno
-  Renovierungsnut außen

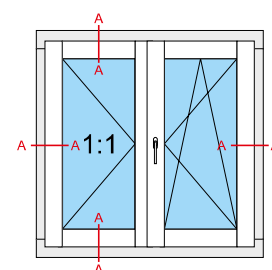

STD-68-R-005

Standard 68mm „S”

Standard 68mm „R”

Classik 68mm „S”

Classik 68mm „R”

Style 01 68mm „S”

Style 01 68mm „R”

Standard 68mm „S”

Standard 68mm „R”

Classik 68mm „S”

Classik 68mm „R”





Style 01 68mm „S”

Style 01 68mm „R”

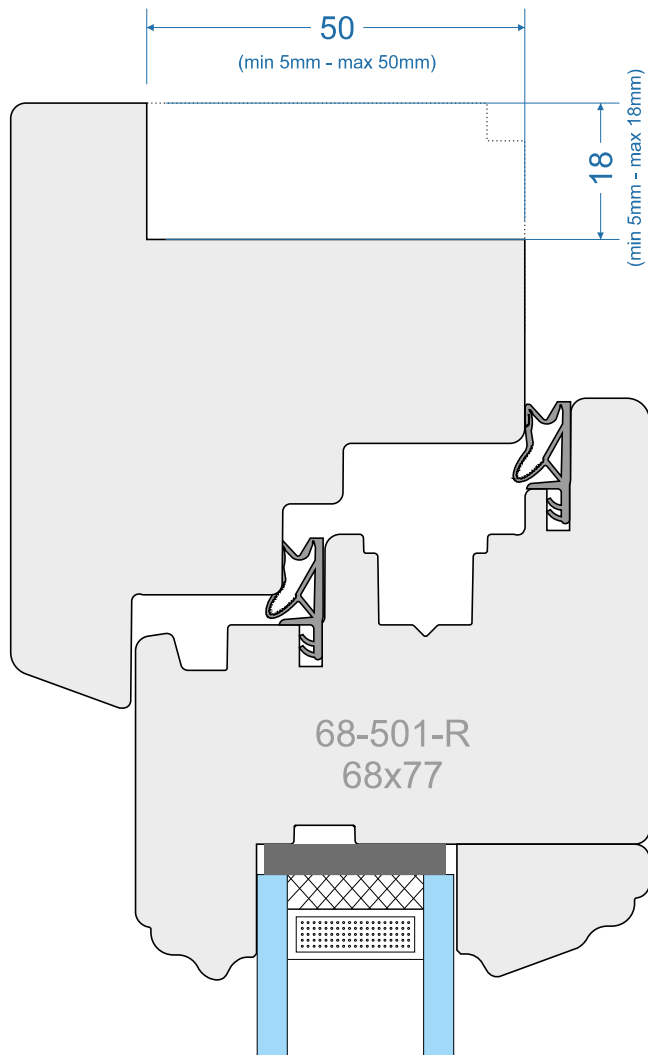
out

in





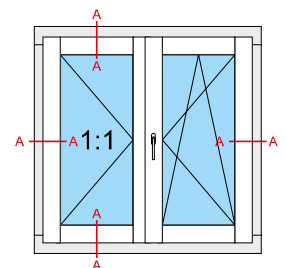



-  Frez renowacyjny od wewnątrz
-  Renovation groove from the inside
-  Rainure de rénovation à l'intérieur
-  Scanalatura di ristrutturazione all'interno
-  Renovierungsnut auf der Innenseite

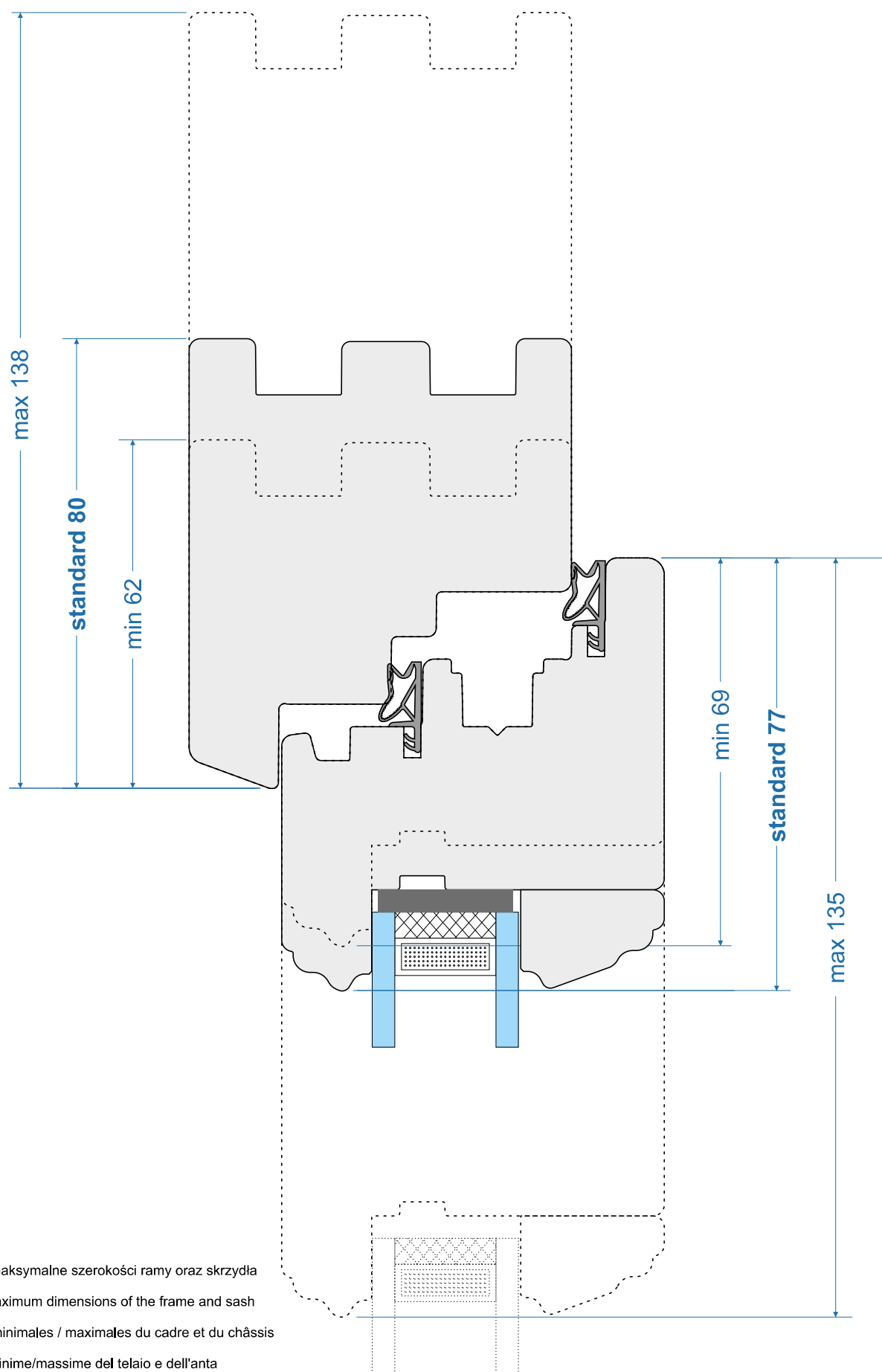

out

in



-  Minimalne / maksymalne szerokości ramy oraz skrzydła
-  Minimum / maximum dimensions of the frame and sash
-  Dimensions minimales / maximales du cadre et du châssis
-  Dimensioni minime/massime del telaio e dell'anta
-  Minimale / maximale breite des rahmen und des flügels

STD-68-R-007

Standard 68mm „S”

Standard 68mm „R”

Classik 68mm „S”

Classik 68mm „R”

Style 01 68mm „S”

Style 01 68mm „R”

out

in

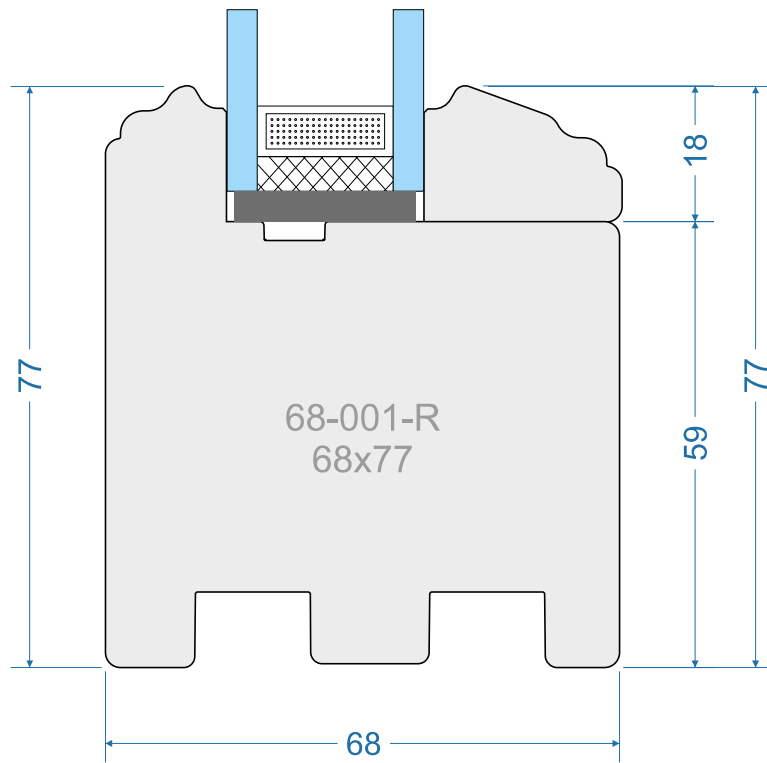

-  Fix w ramie
-  Fixed window
-  Chassis fixe
-  Finestra fissa
-  Fenster fest im rahmen

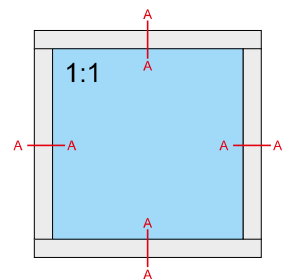

STD-68-R-008



out

in

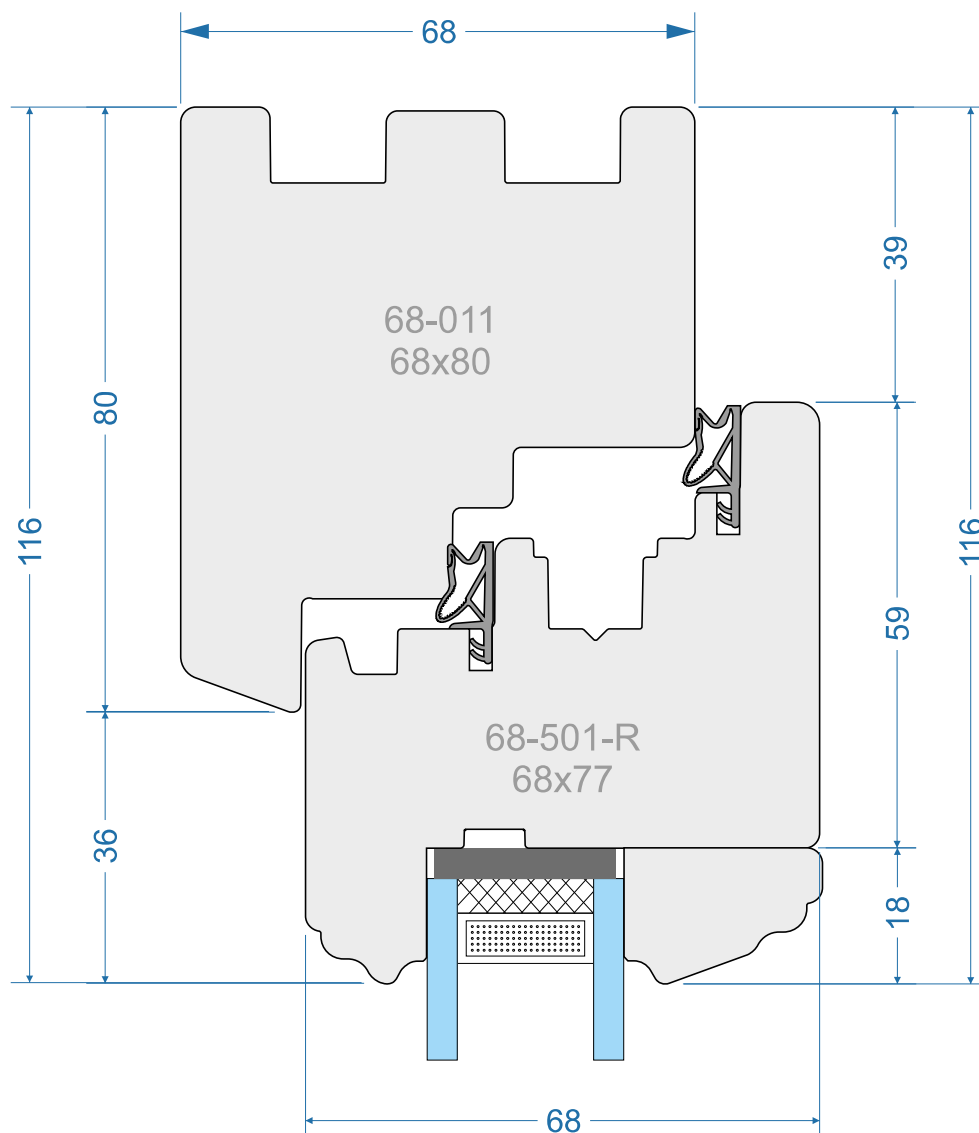

-  Rama + skrzydło
-  Frame + sash
-  Cadre + ouvrant
-  Telaio + anta
-  Rahmen + Flügel

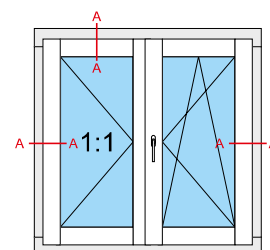

STD-68-R-009

Standard 68mm „S”

Standard 68mm „R”

Classik 68mm „S”

Classik 68mm „R”

Style 01 68mm „S”

Style 01 68mm „R”

out

in

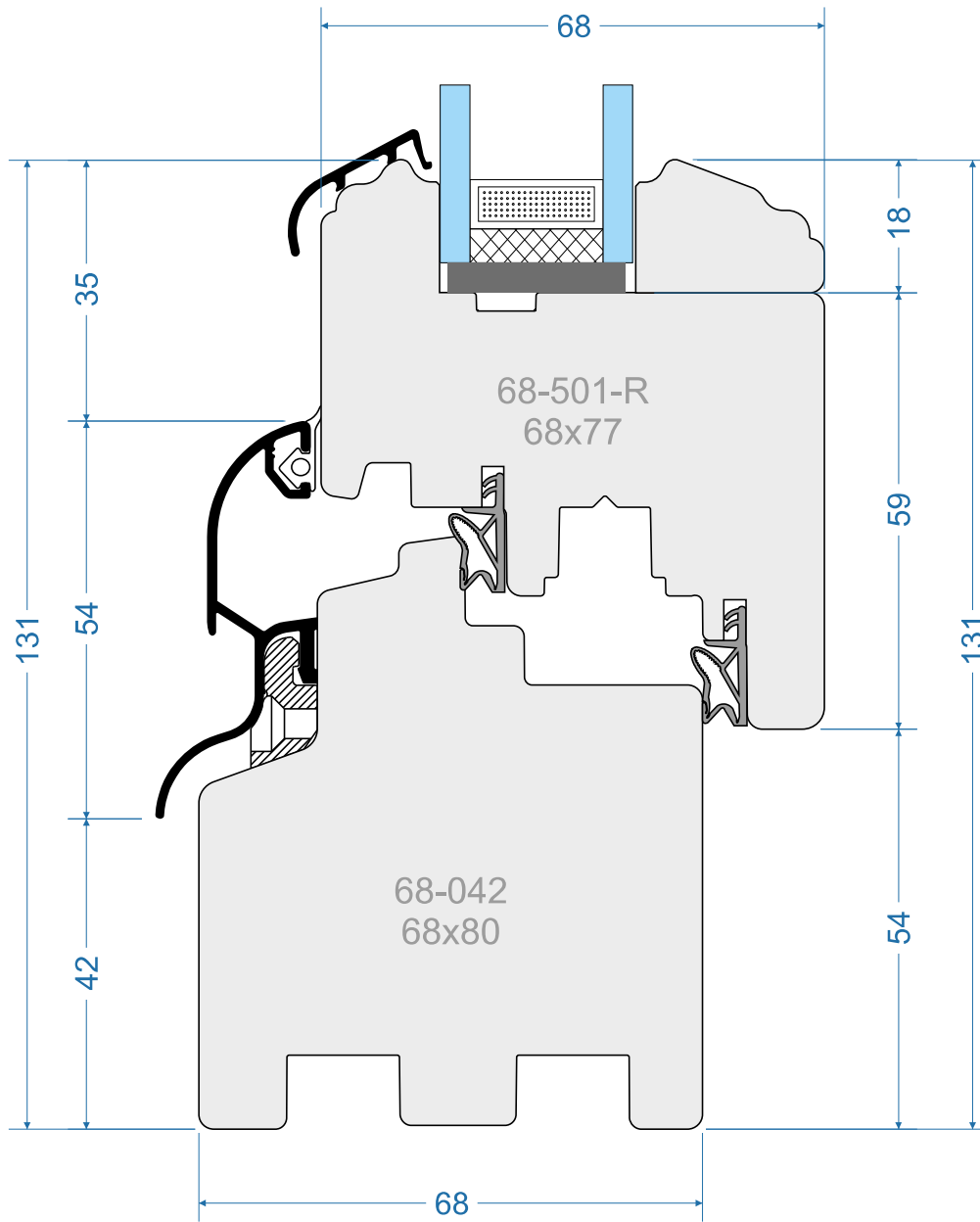

-  Rama + skrzydło
-  Frame + sash
-  Cadre + ouvrant
-  Telaio + anta
-  Rahmen + Flügel

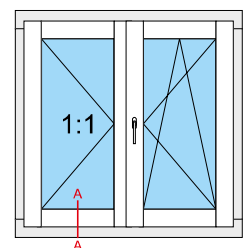

out

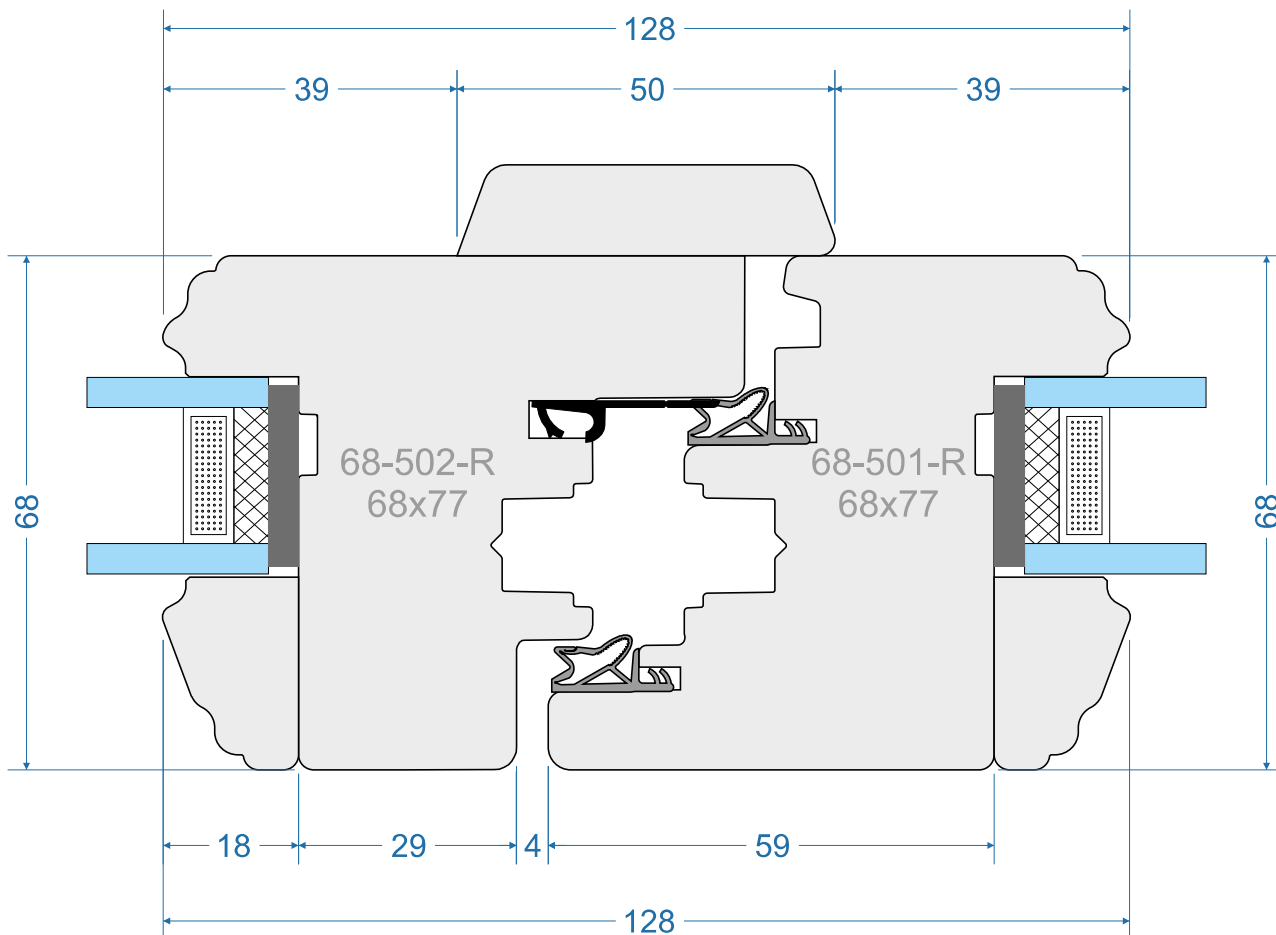

in

-  Stupek ruchomy
-  Moveable post
-  Meneau mobile
-  Montante mobile
-  Stulp

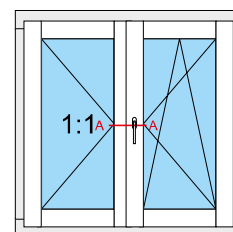

STD-68-R-0011

Standard 68mm „S”

Standard 68mm „R”

Classik 68mm „S”

Classik 68mm „R”

Style 01 68mm „S”

Style 01 68mm „R”

Standard 68mm „S”

Standard 68mm „R”

Classik 68mm „S”

Classik 68mm „R”



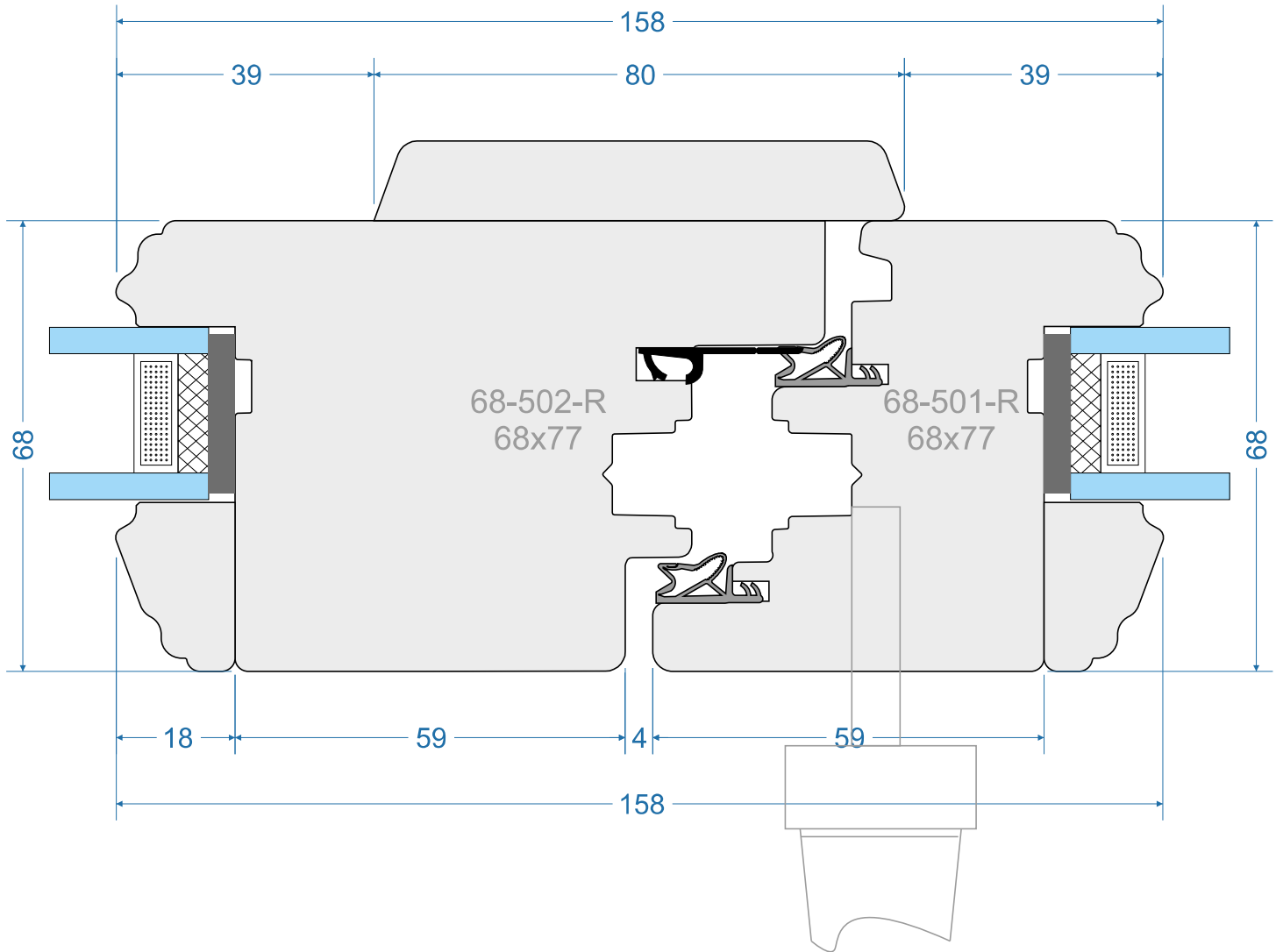

Style 01 68mm „S”

Style 01 68mm „R”

out



in



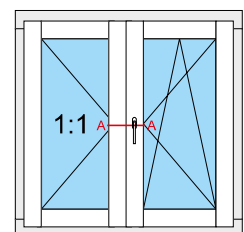

-  Stupek ruchomy - równe elementy
-  Movable post - equal elements
-  Meneau mobile - éléments égaux
-  Montante mobile - elementi simmetrici
-  Stulp - gleiche Elemente

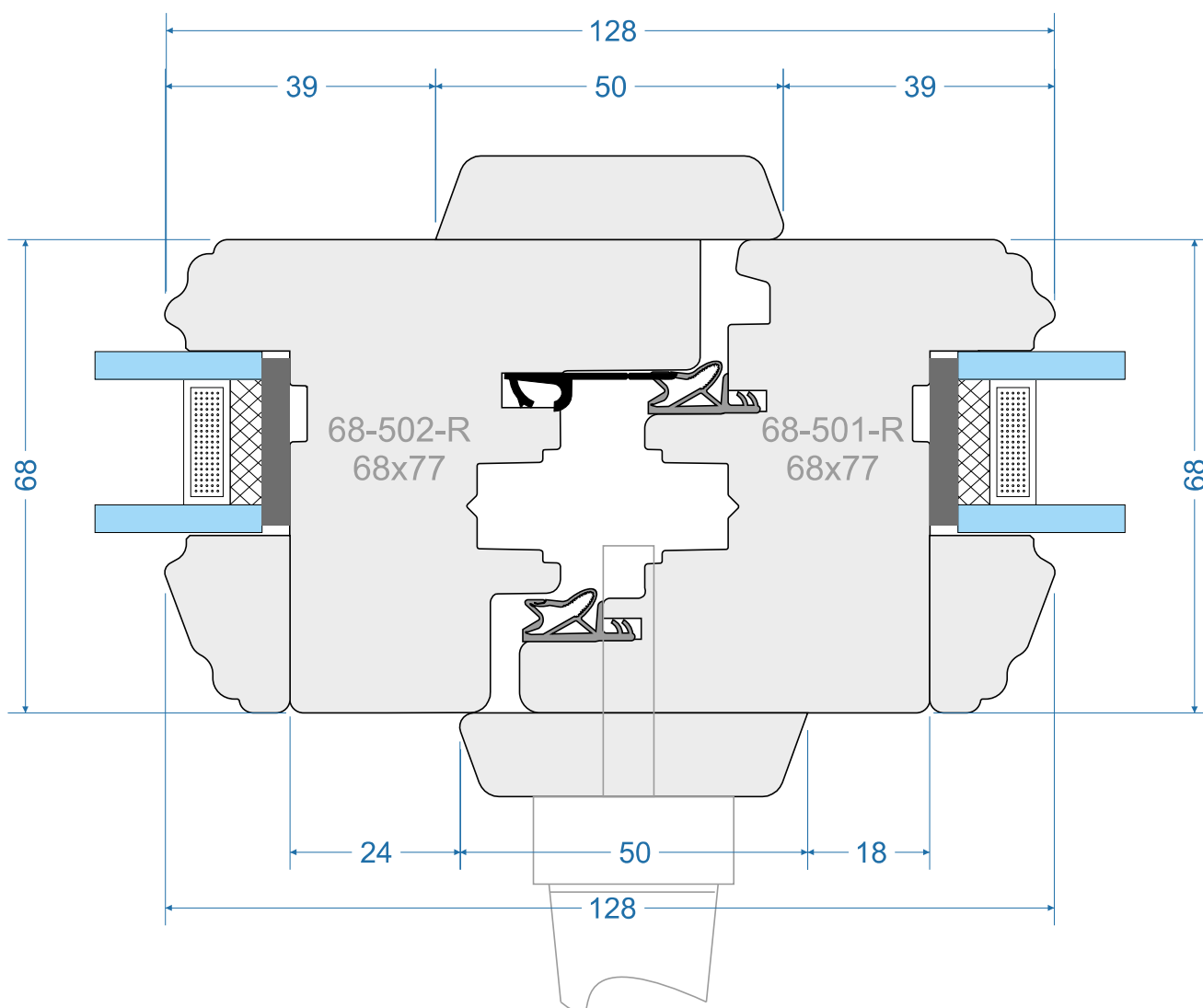

out



in

-  Stupek ruchomy - klamka centralna
-  Moveable post - central handle
-  Meneau mobile - poignée centrale
-  Montante mobile - maniglia centrale (entrata zero)
-  Stulp - zentraler Griff

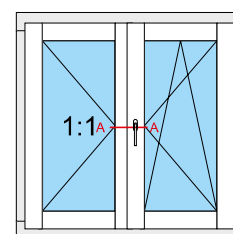

STD-68-R-0013

Standard 68mm „S”

Standard 68mm „R”

Classik 68mm „S”

Classik 68mm „R”

Style 01 68mm „S”

Style 01 68mm „R”

Standard 68mm „S”

Standard 68mm „R”

Classik 68mm „S”

Classik 68mm „R”



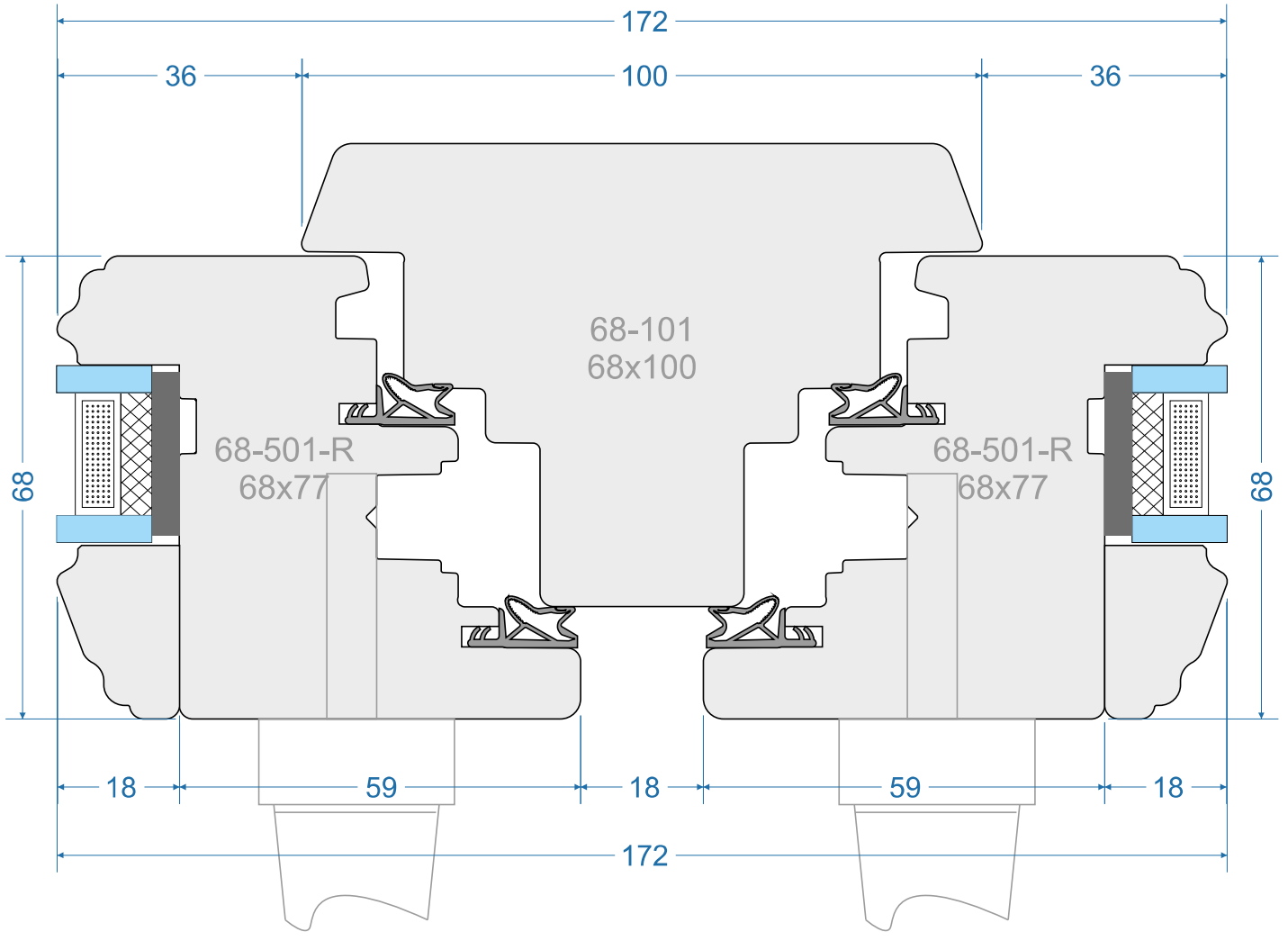

Style 01 68mm „S”

Style 01 68mm „R”

out



in

-  Stupek staly 100mm
-  Fixed post 100mm
-  Meneau fixe 100mm
-  Montante verticale fisso 100mm
-  Festen pfosten 100mm

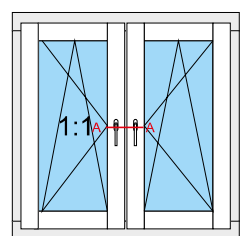

out

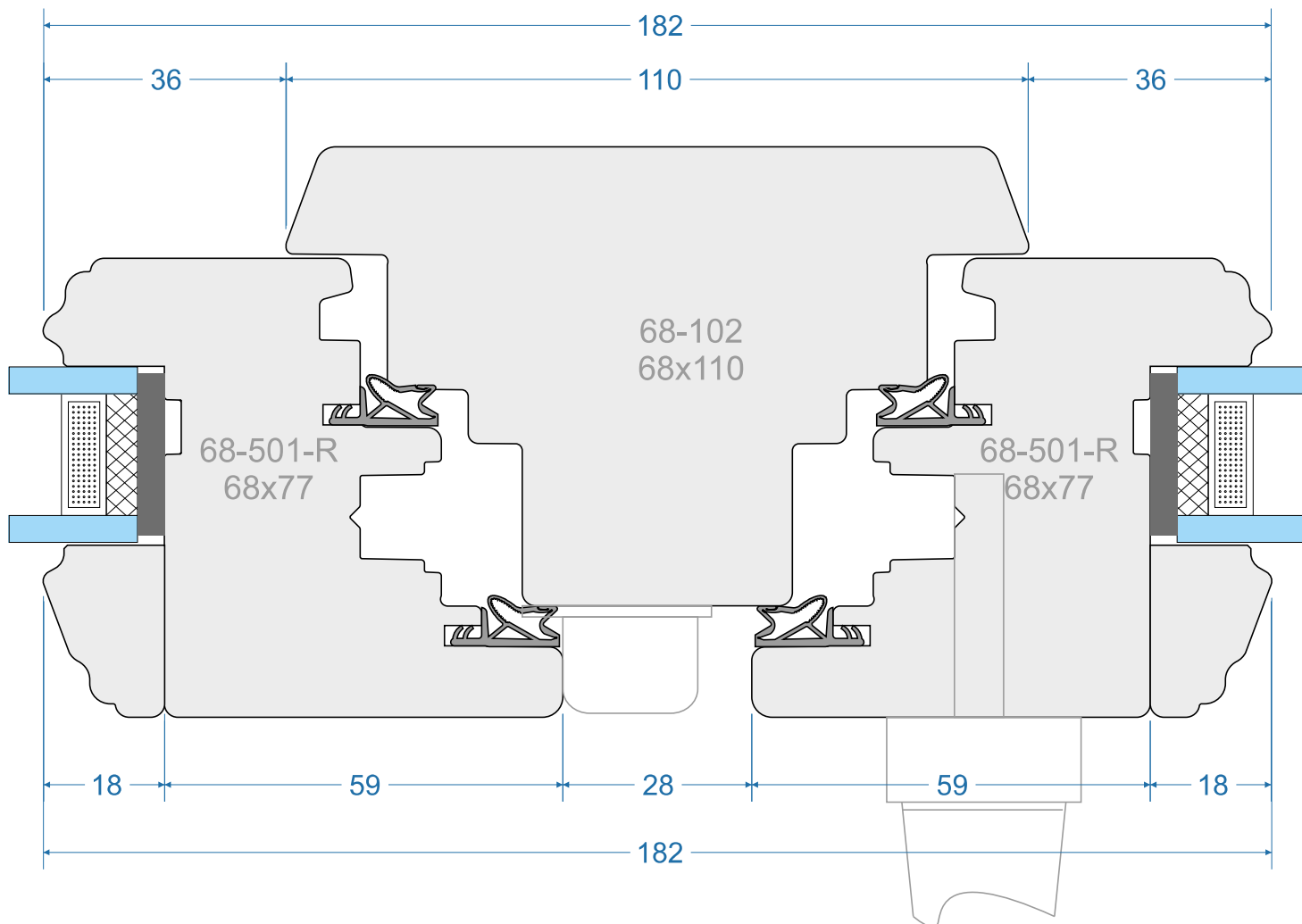

in

-  Słupek stalowy 110mm
-  Fixed post 110mm
-  Meneau fixe 110mm
-  Montante verticale fisso 110mm
-  Festen pfosten 110mm

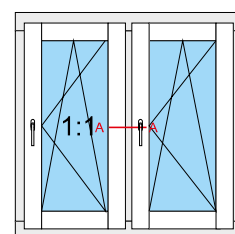

STD-68-R-0015

Standard 68mm „S”

Standard 68mm „R”

Classik 68mm „S”

Classik 68mm „R”

Style 01 68mm „S”

Style 01 68mm „R”

Standard 68mm „S”

Standard 68mm „R”

Classik 68mm „S”

Classik 68mm „R”





Style 01 68mm „S”

Style 01 68mm „R”

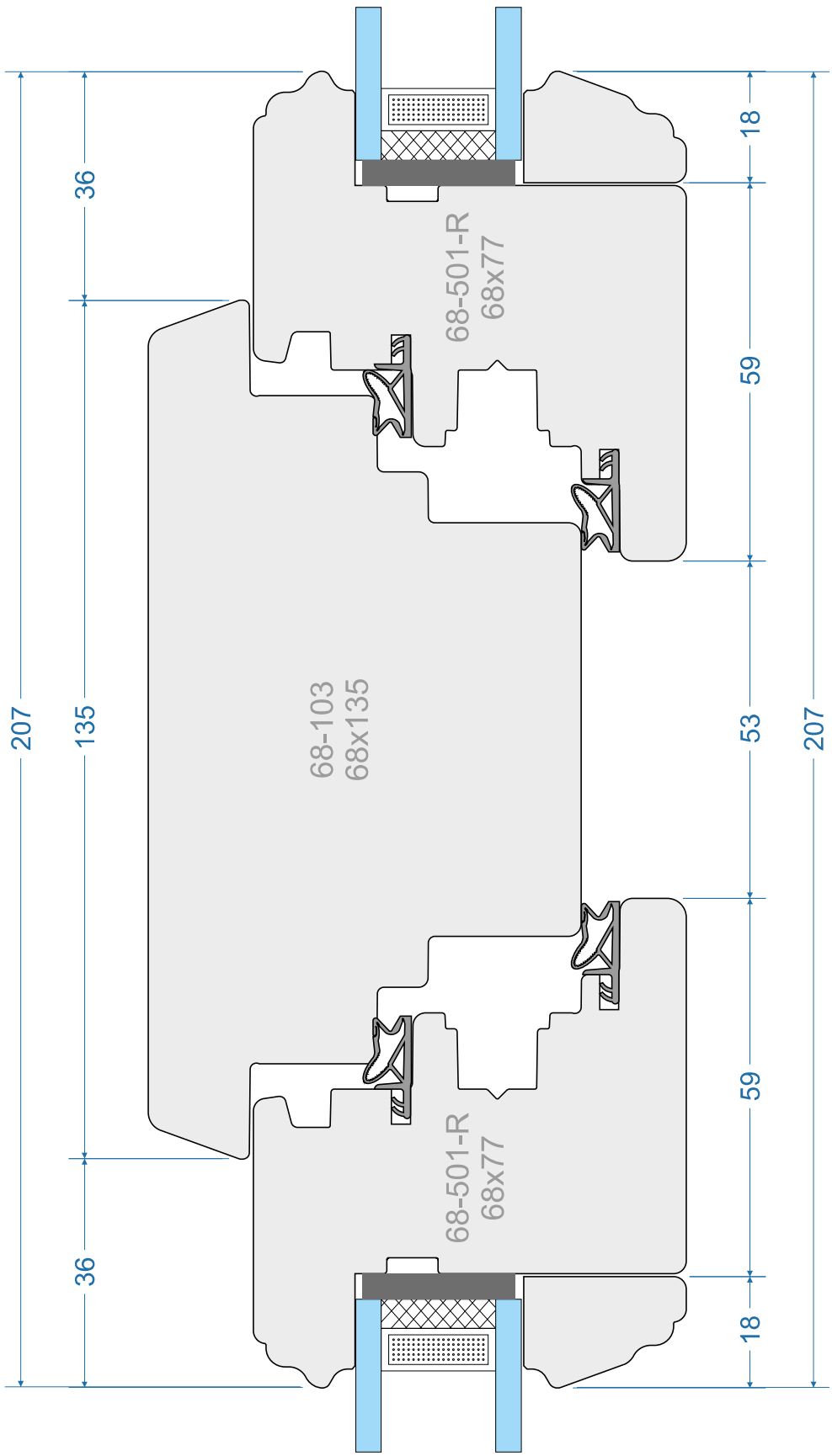
out

in



-  Słupki stalowe 135mm
-  Fixed post 135mm
-  Meneau fixe 135mm
-  Montante orizzontale fissa 135mm
-  Festen pfosten 135mm

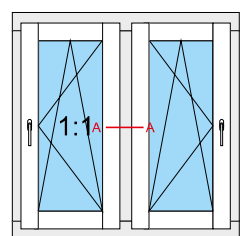





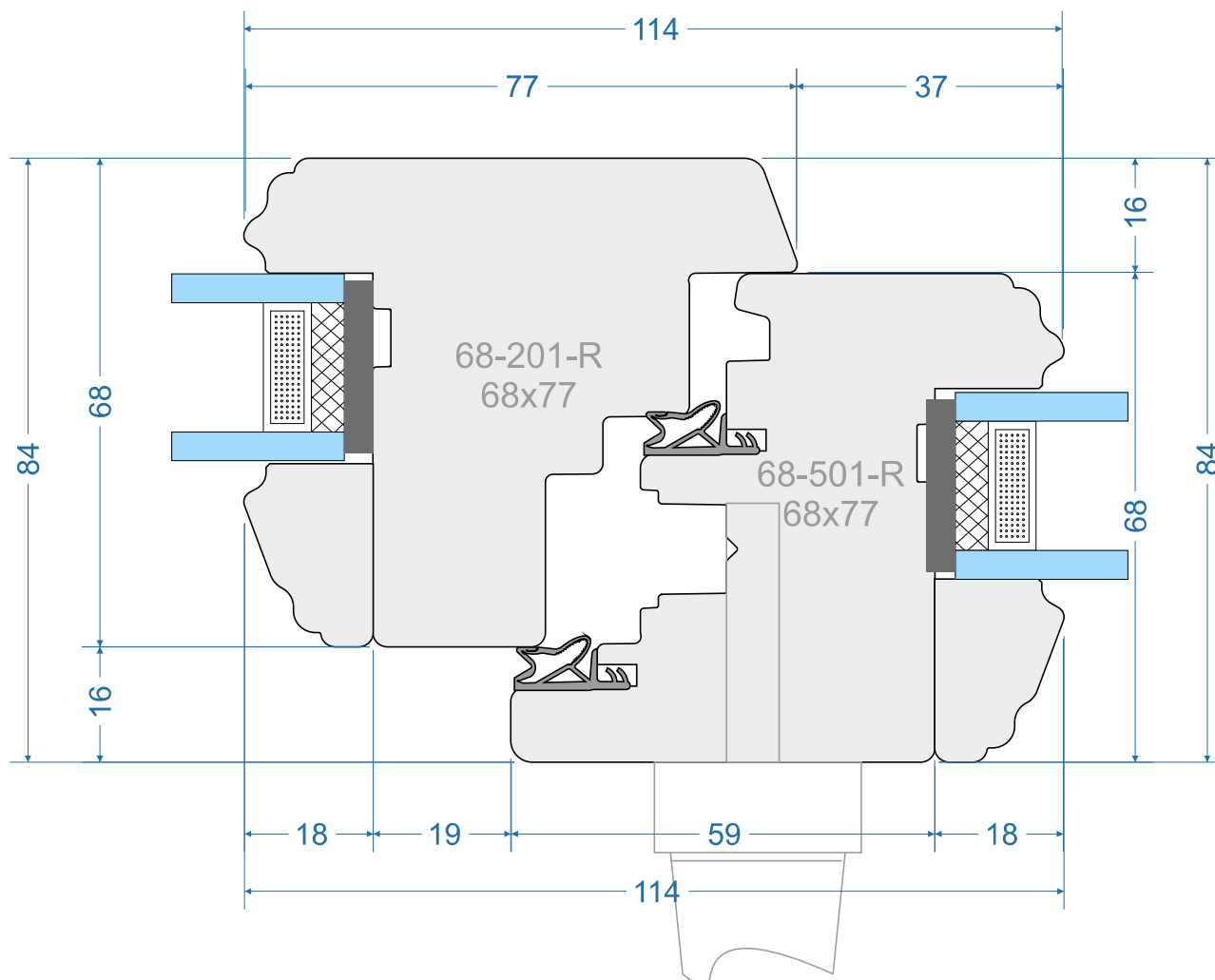

out



in

-  Słupek - skrzydło + fix
-  Post - sash + fix
-  Meneau - ouvrant + fixe
-  Accoppiamento telaio fisso - anta mobile
-  Pfosten - Flügel + Fix

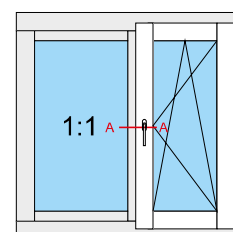

STD-68-R-0017

Standard 68mm „S”

Standard 68mm „R”

Classik 68mm „S”

Classik 68mm „R”



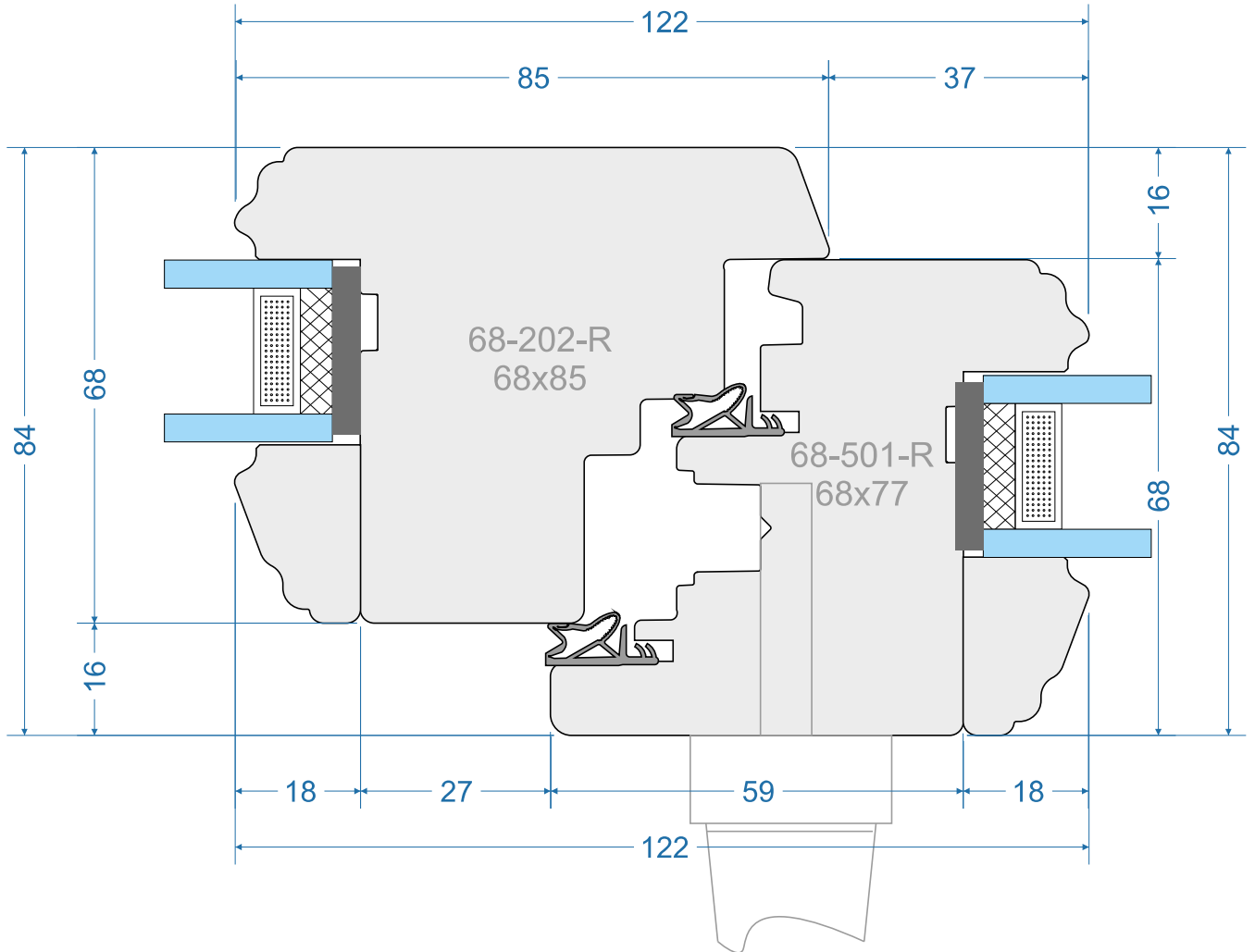

Style 01 68mm „S”

Style 01 68mm „R”

out



in

-  Stupek - skrzydło + fix
-  Post - sash + fix
-  Meneau - ouvrant+ fixe
-  Accoppiamento telaio fisso - anta mobile
-  Pfosten - Flügel + Fix

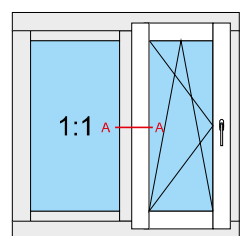

Standard 68mm „S”

Standard 68mm „R”

Classik 68mm „S”

Classik 68mm „R”

Style 01 68mm „S”

Style 01 68mm „R”

out

in

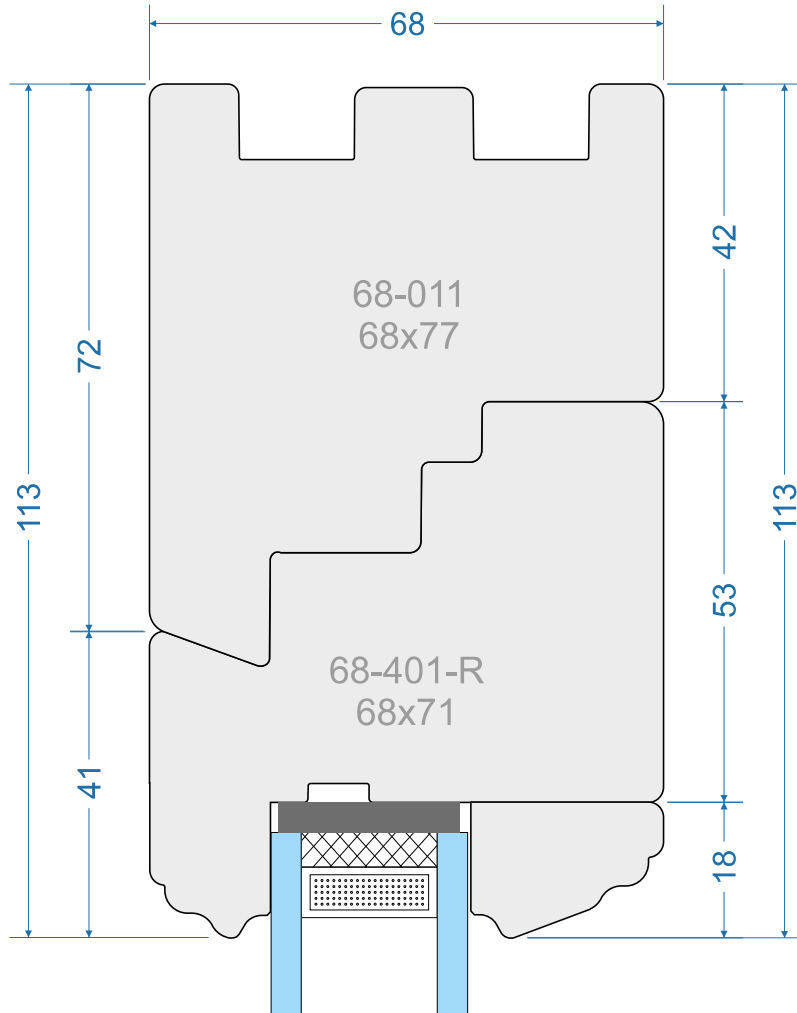

-  Wyrównanie górne
-  Top alignment
-  Alignement supérieur
-  Allineamento superiore
-  Ausrichtung nach oben

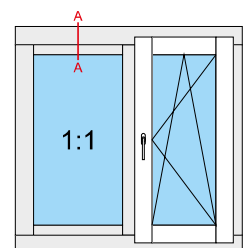

STD-68-R-0019

Standard 68mm „S”

Standard 68mm „R”

Classik 68mm „S”

Classik 68mm „R”

Style 01 68mm „S”

Style 01 68mm „R”

Standard 68mm „S”

Standard 68mm „R”

Classik 68mm „S”

Classik 68mm „R”

Style 01 68mm „S”

Style 01 68mm „R”

out

in

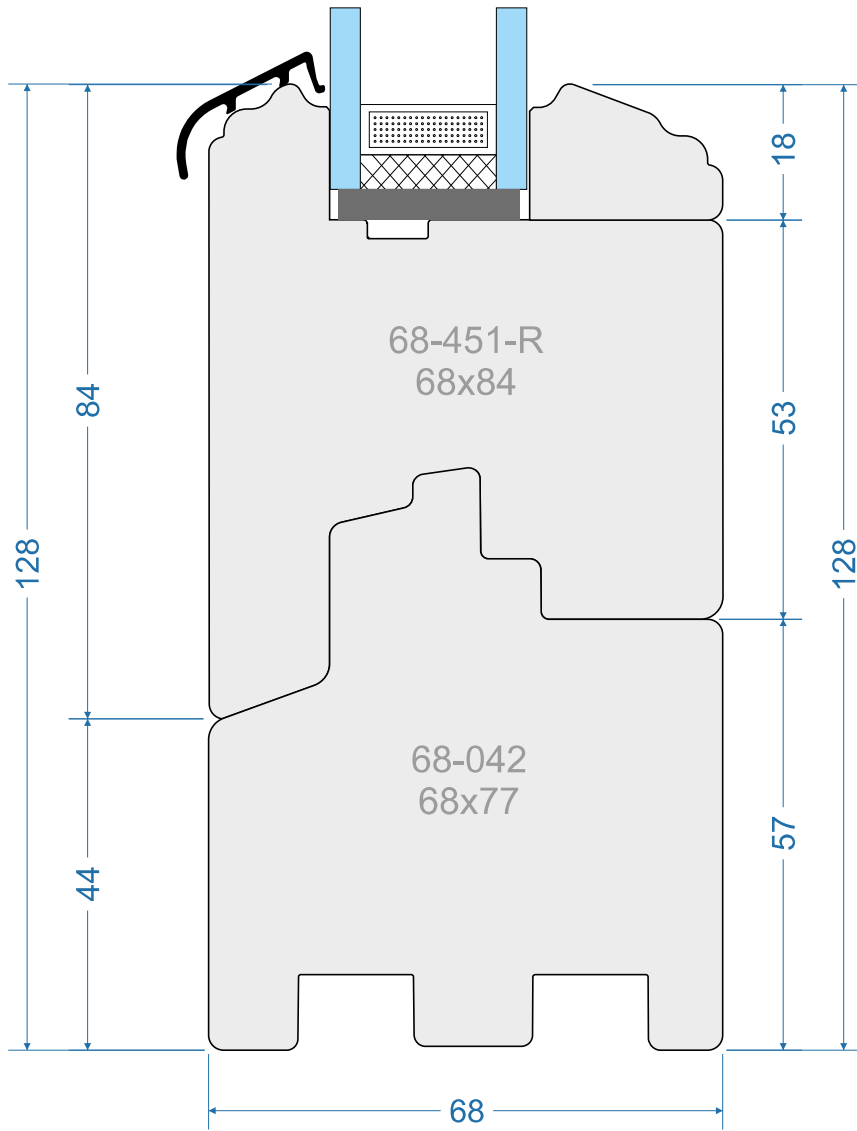



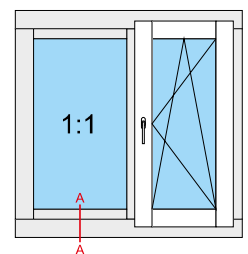



-  Wyrównanie dolne
-  Bottom alignment
-  Alignement en bas
-  Allineamento inferiore
-  Ausrichtung nach unten

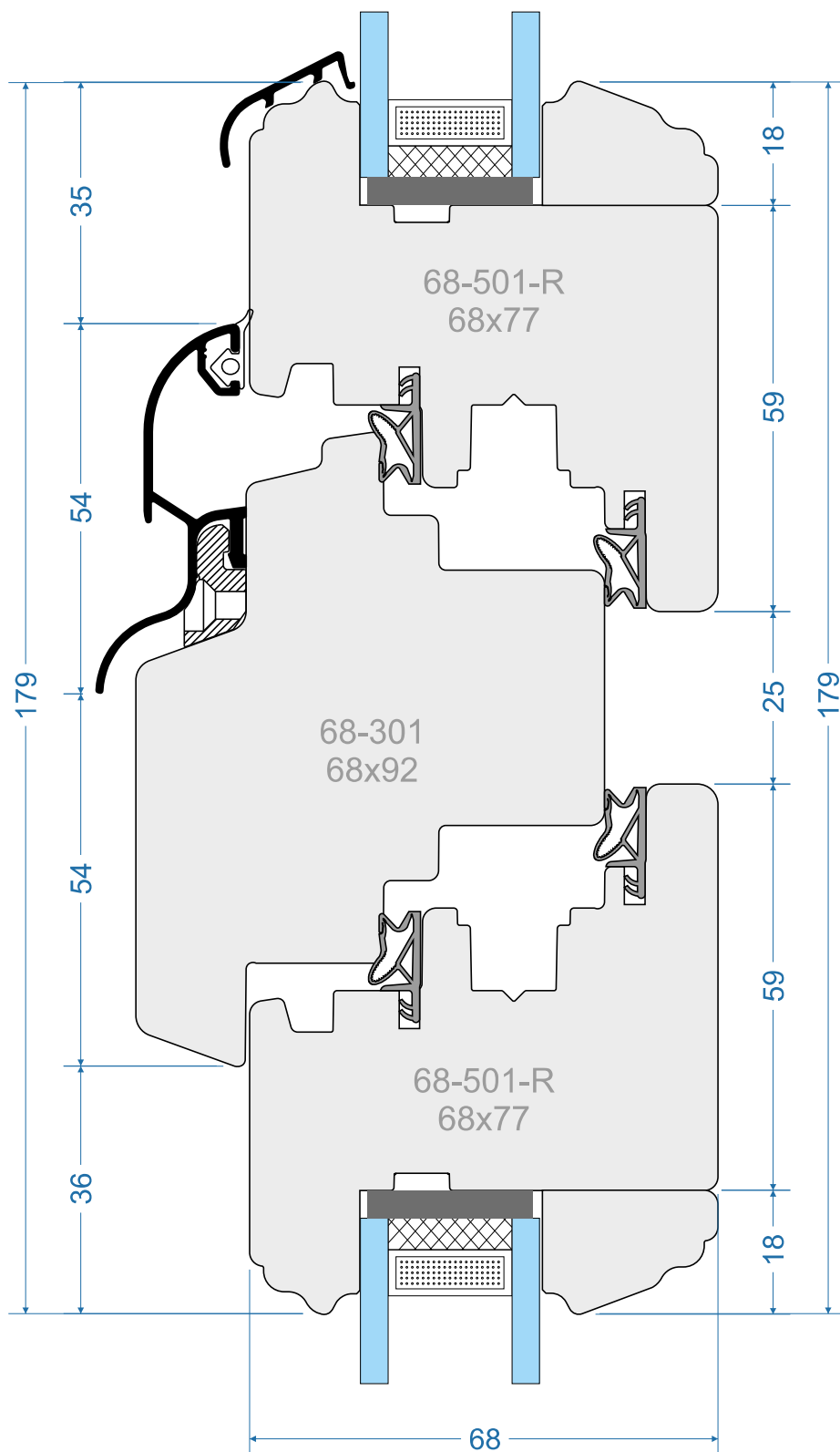

out

in



-  Słupek poziomy - skrzydło + skrzydło
-  Horizontal post - sash + sash
-  Traverse - ouvrant + ouvrant
-  Montante orizzontale - anta + anta
-  Horizontaler Pfosten - Flügel + Flügel

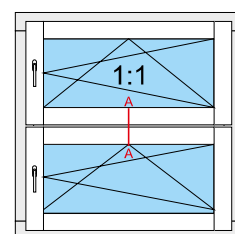

STD-68-R-0021

Standard 68mm „S”

Standard 68mm „R”

Classik 68mm „S”

Classik 68mm „R”





Style 01 68mm „S”

Style 01 68mm „R”

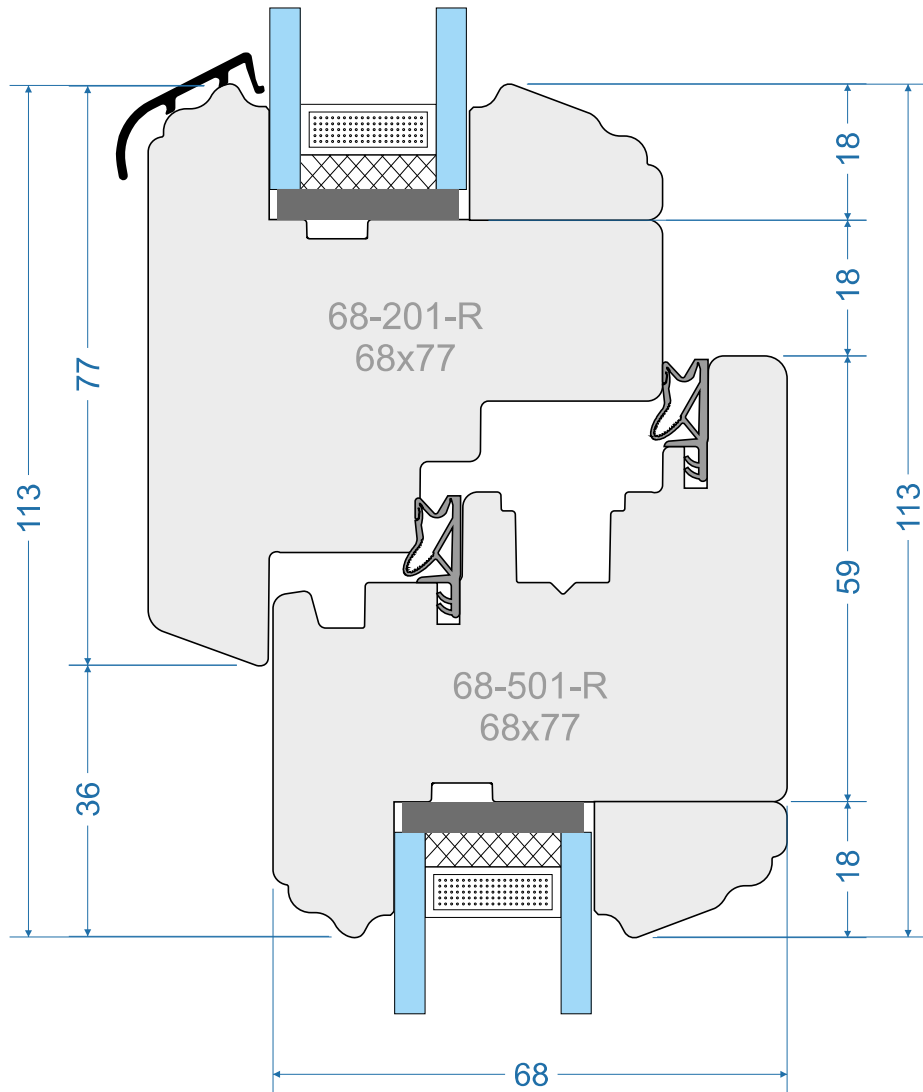
out

in





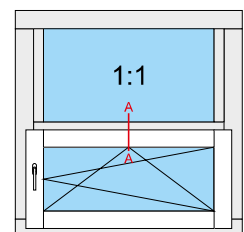



-  Słupek poziomy - fix + skrzydło
-  Horizontal post - fix + sash
-  Traverse - fixe + ouvrant
-  Montante orizzontale - fisso + anta
-  Horizontaler Pfosten - Fix + Flügel

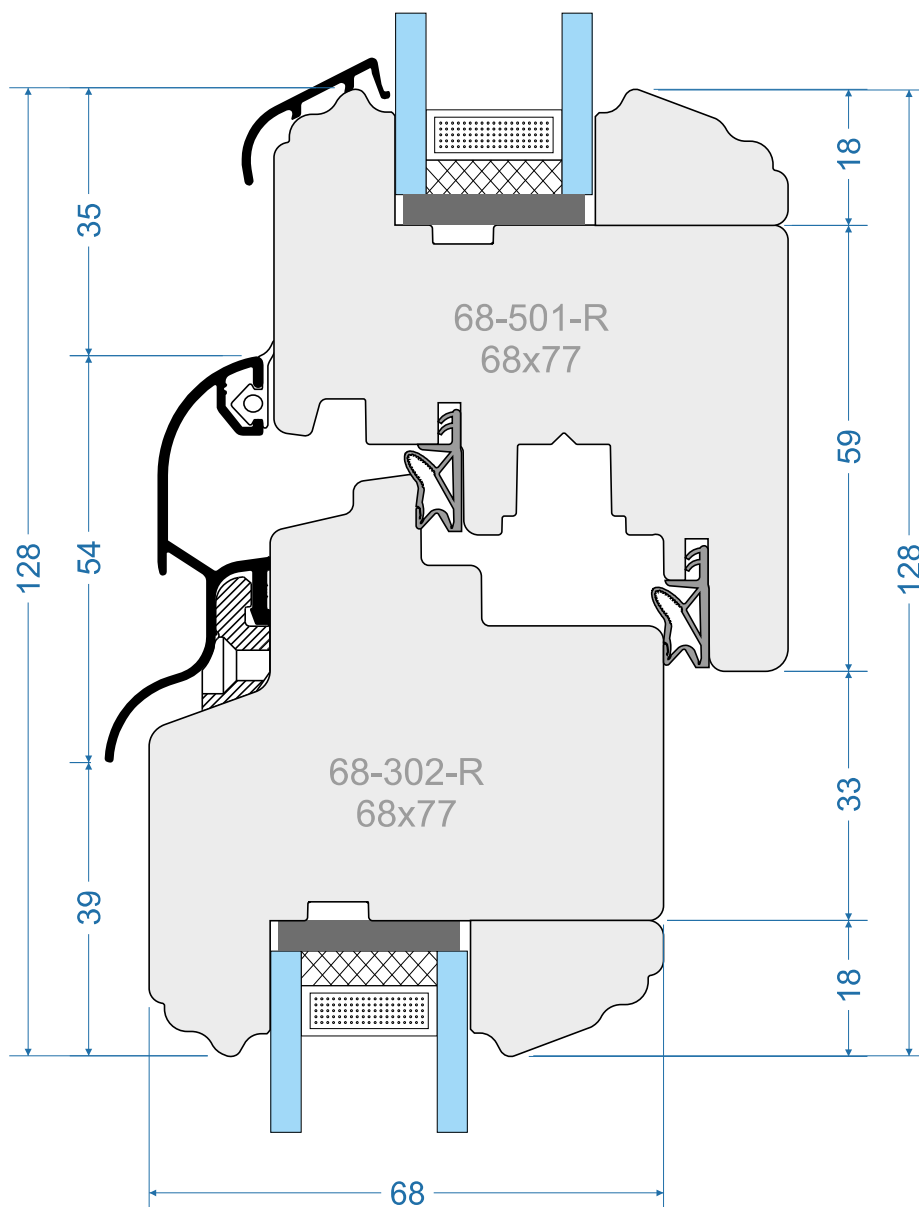

out

in



-  Słupek poziomy - skrzydło + fix
-  Horizontal post - sash + fix
-  Traverse- ouvrant + fixe
-  Montante orizzontale - anta + fisso
-  Horizontaler Pfosten - Flügel + Fix

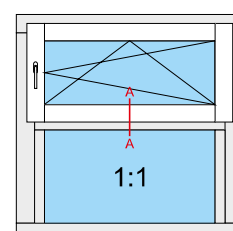

STD-68-R-0023

Standard 68mm „S”

Standard 68mm „R”

Classik 68mm „S”

Classik 68mm „R”

Style 01 68mm „S”

Style 01 68mm „R”

out

in

Standard 68mm „S”

Standard 68mm „R”

Classik 68mm „S”

Classik 68mm „R”

Style 01 68mm „S”

Style 01 68mm „R”

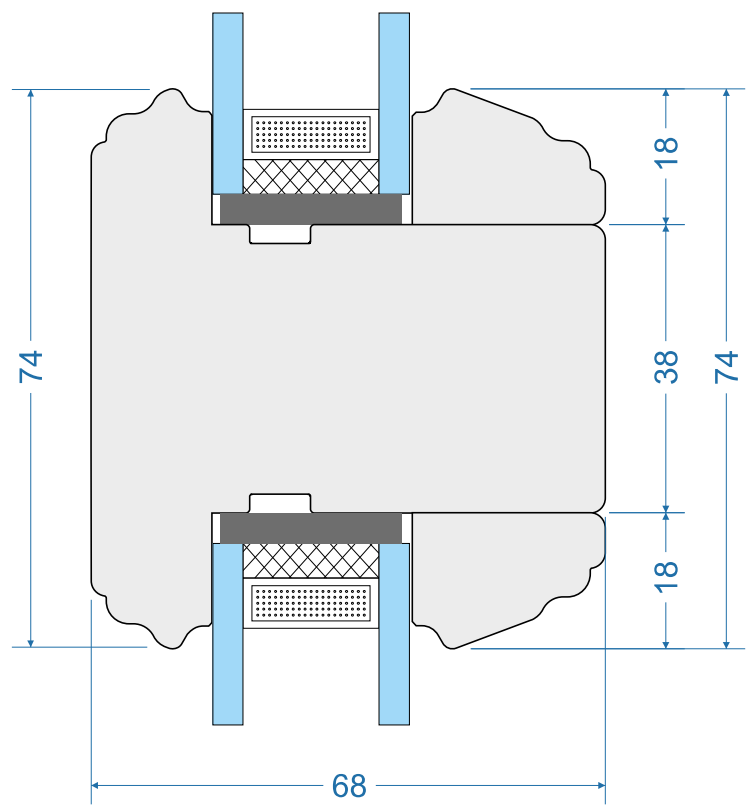

-  Poprzeczka
-  Bar
-  Traversine
-  Traverso
-  Bar

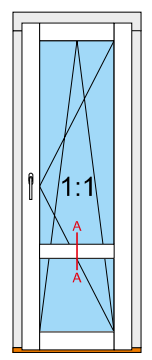





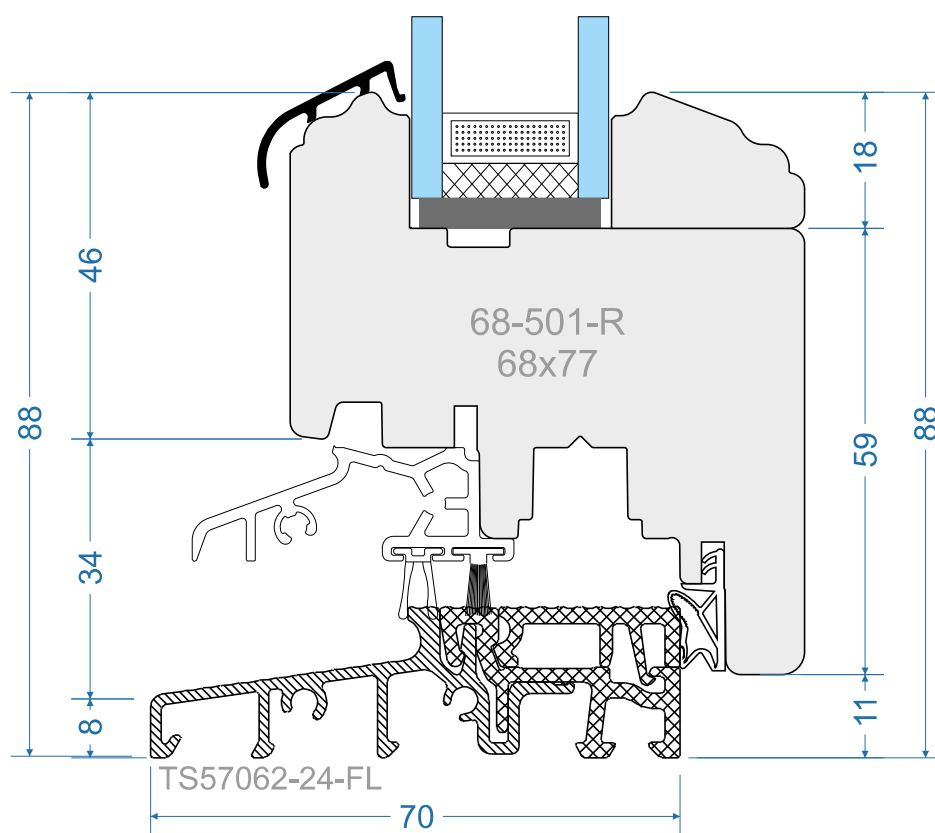

out

in



-  Próg aluminiowy + skrzydło 77mm
-  Aluminum threshold + sash 77mm
-  Seuil en aluminium + châssis 77mm
-  Soglia in alluminio + anta 77mm
-  Aluminiumschwelle + Flügel 77mm

STD-68-R-0025

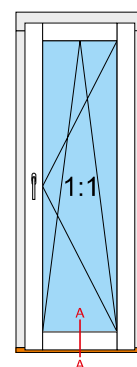

Standard 68mm „S”

Standard 68mm „R”

Classik 68mm „S”

Classik 68mm „R”

Style 01 68mm „S”

Style 01 68mm „R”

out

in

Standard 68mm „S”

Standard 68mm „R”





Classik 68mm „S”

Classik 68mm „R”

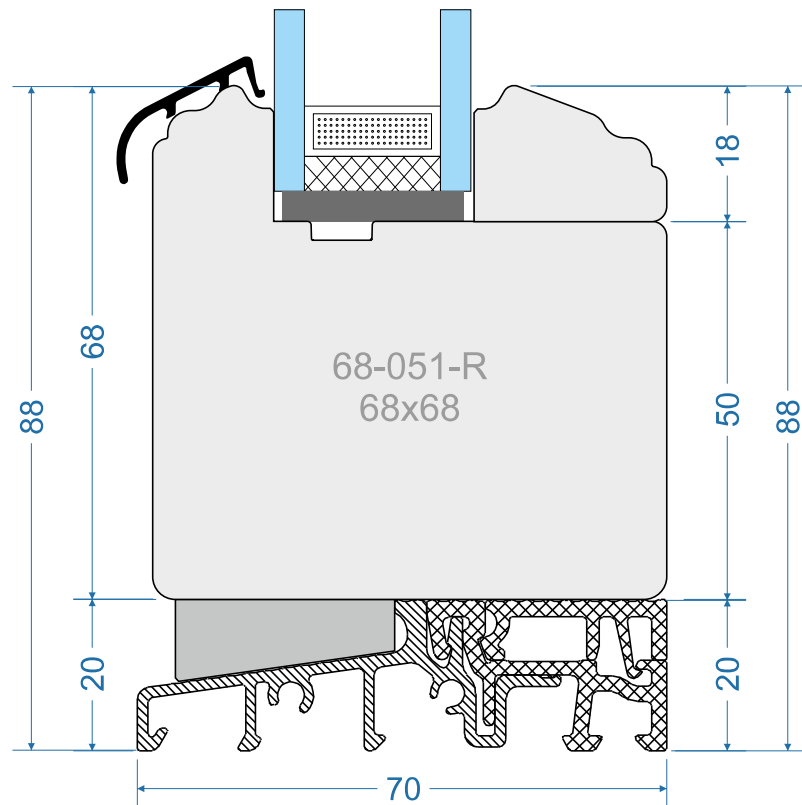
Style 01 68mm „S”

Style 01 68mm „R”



-  Wyrównanie do „Próg aluminiowy + skrzydło 77mm”
-  Alignment to „Aluminum threshold + sash 77mm”
-  Alignement sur le „Seuil en aluminium + châssis 77mm”
-  Allineamento alla „Soglia in alluminio + anta 77mm”
-  Ausrichtung an der „Aluminiumschwelle + Flügel 77mm”

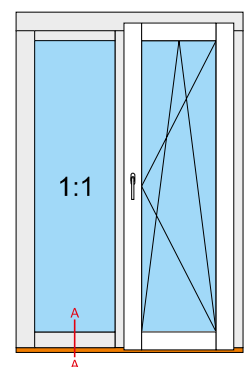



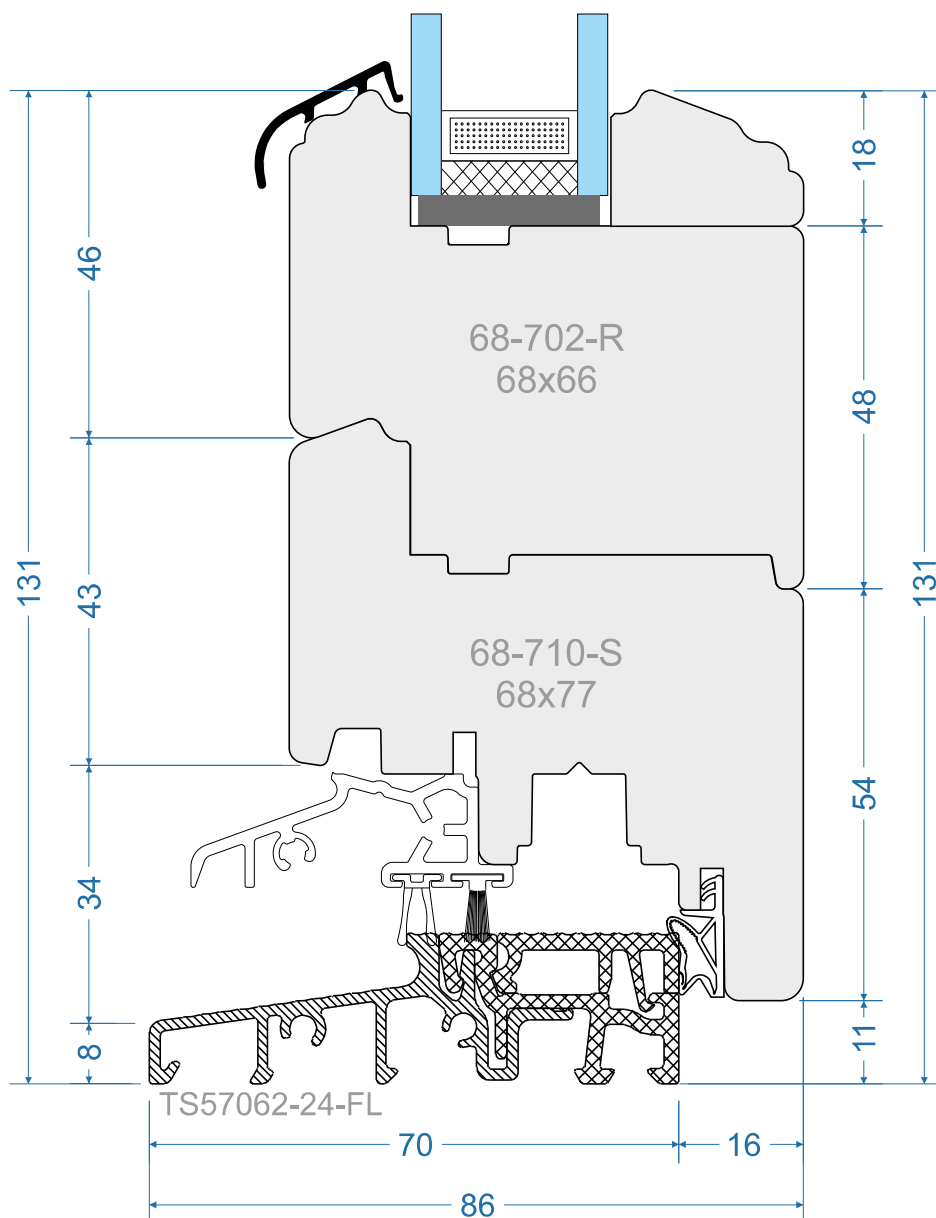

STD-68-R-0026

out

in



-  Próg aluminiowy + skrzydło 77mm + cokół 66mm
-  Aluminum threshold + sash 77mm + plinth 66mm
-  Seuil en aluminium + châssis 77mm + socle 66mm
-  Soglia in alluminio + anta 77mm + zoccolo 66mm
-  Aluminiumschwelle + Flügel 77mm + Sockel 66mm

STD-68-R-0027

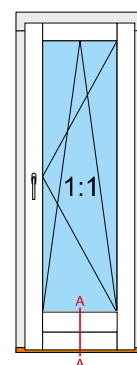

Standard 68mm „S”

Standard 68mm „R”

Classik 68mm „S”

Classik 68mm „R”





Style 01 68mm „S”

Style 01 68mm „R”

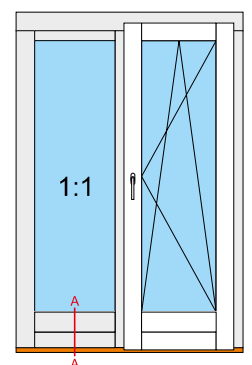
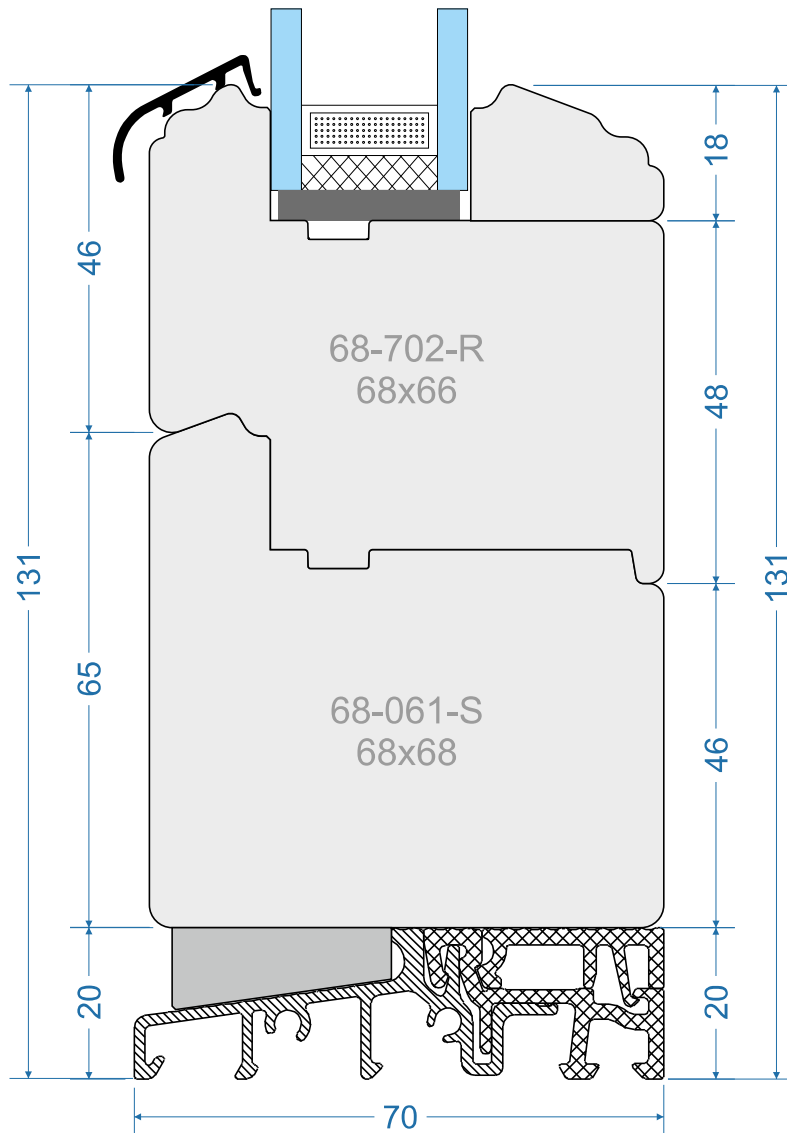
out

in







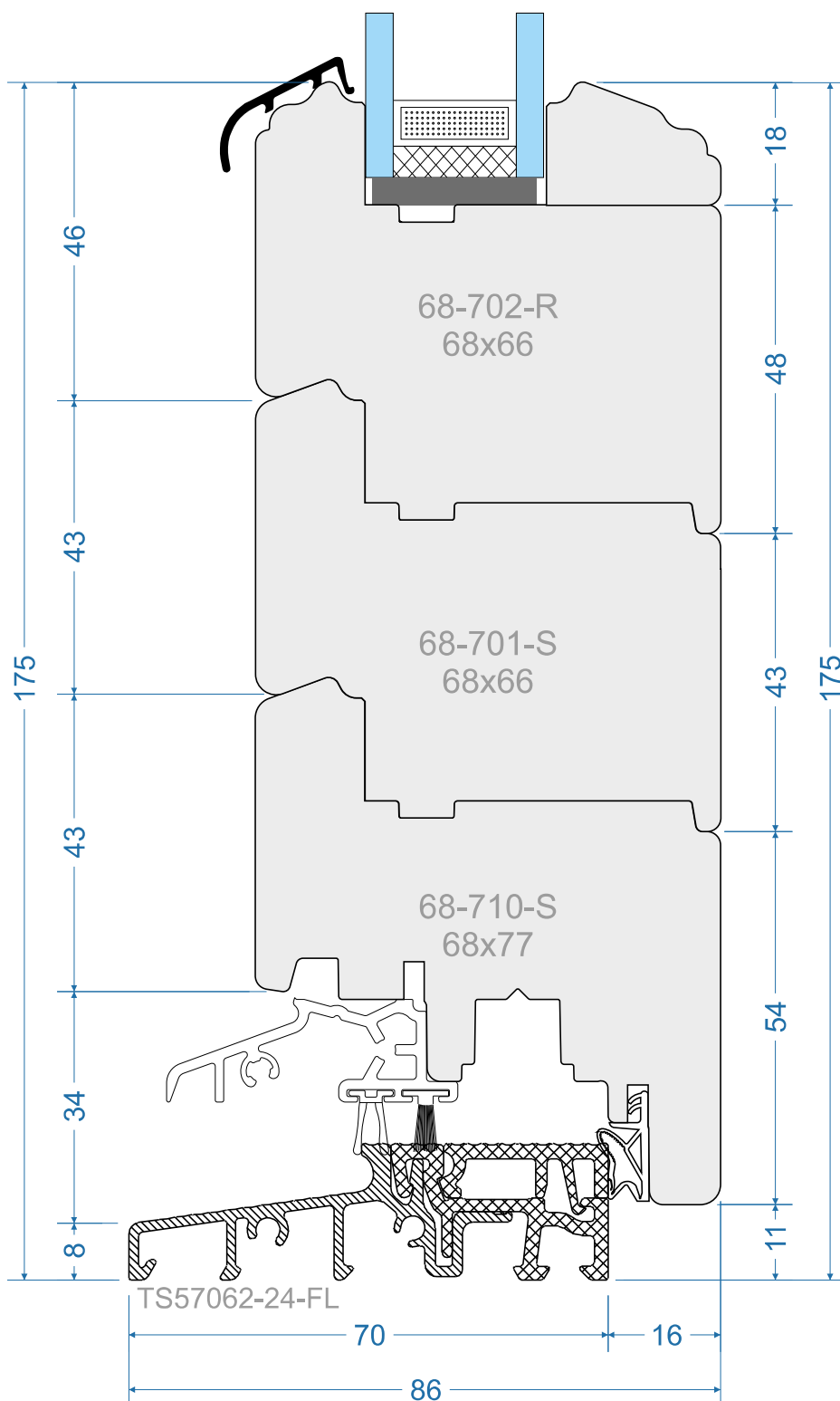

-  Wyrównanie do „Próg aluminiowy + skrzydło 77mm + cokół 66mm”
-  Alignment to „Aluminum threshold + sash 77mm + plinth 66mm”
-  Alignement sur le „Seuil en aluminium + châssis 77mm + socle 66mm”
-  Allineamento alla „Soglia in alluminio + anta 77mm + zoccolo 66mm”
-  Ausrichtung an der „Aluminiumschwelle + Flügel 77mm + Sockel 66mm”

STD-68-R-0028

out

in



-  Próg aluminiowy + skrzydło 77mm + cokół 66mm + cokół 66mm
-  Aluminum threshold + sash 77mm + plinth 66mm + plinth 66mm
-  Seuil en aluminium + châssis 77mm + socle 66mm + socle 66mm
-  Soglia in alluminio + anta 77mm + zoccolo 66mm + zoccolo 66mm
-  Aluminiumschwelle + Flügel 77mm + Sockel 66mm + Sockel 66mm

STD-68-R-0029

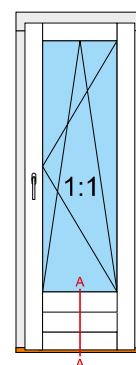

Standard 68mm „S”

Standard 68mm „R”

Classik 68mm „S”

Classik 68mm „R”





Style 01 68mm „S”

Style 01 68mm „R”

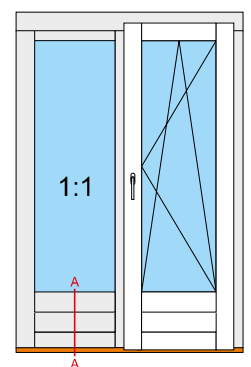
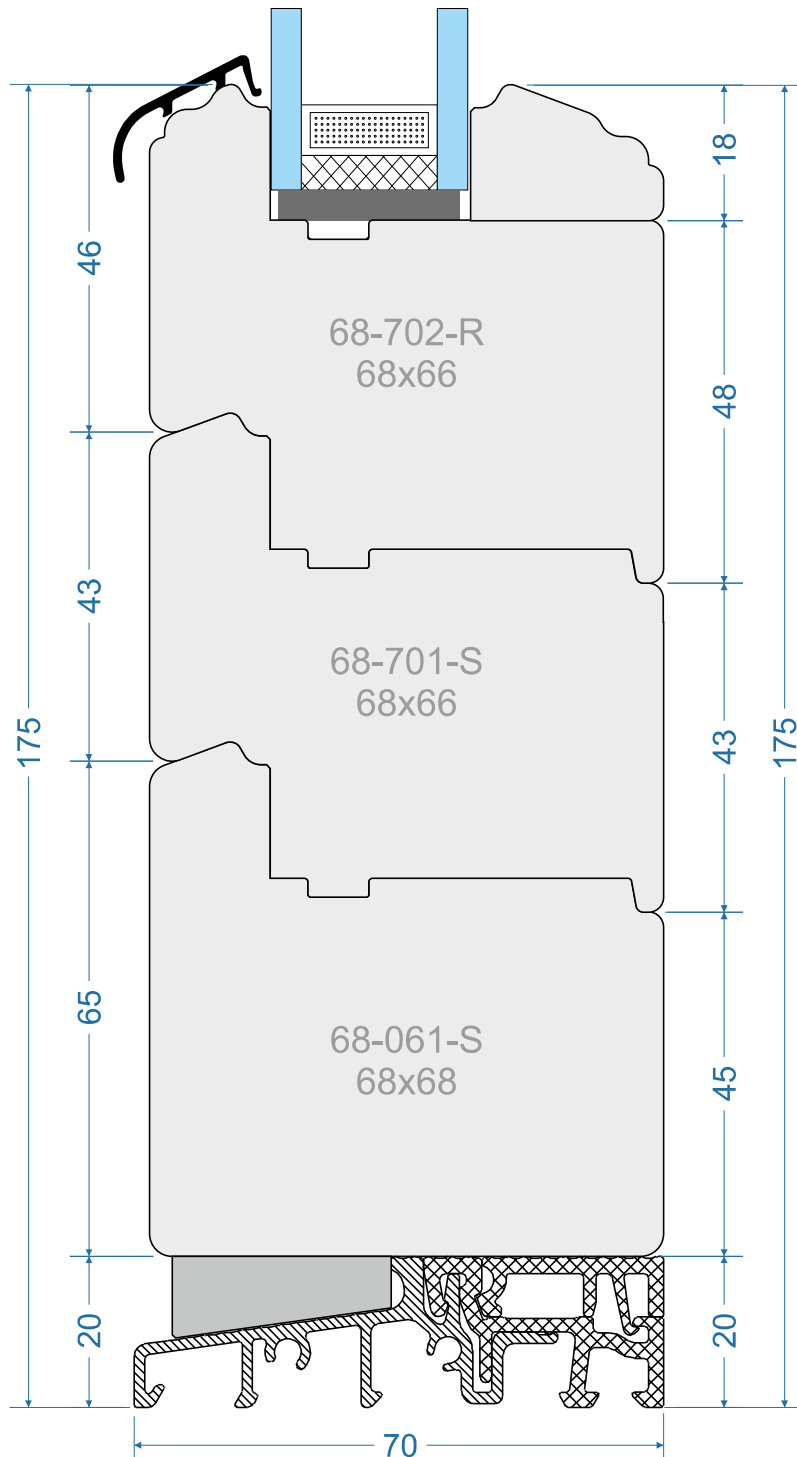
out

in







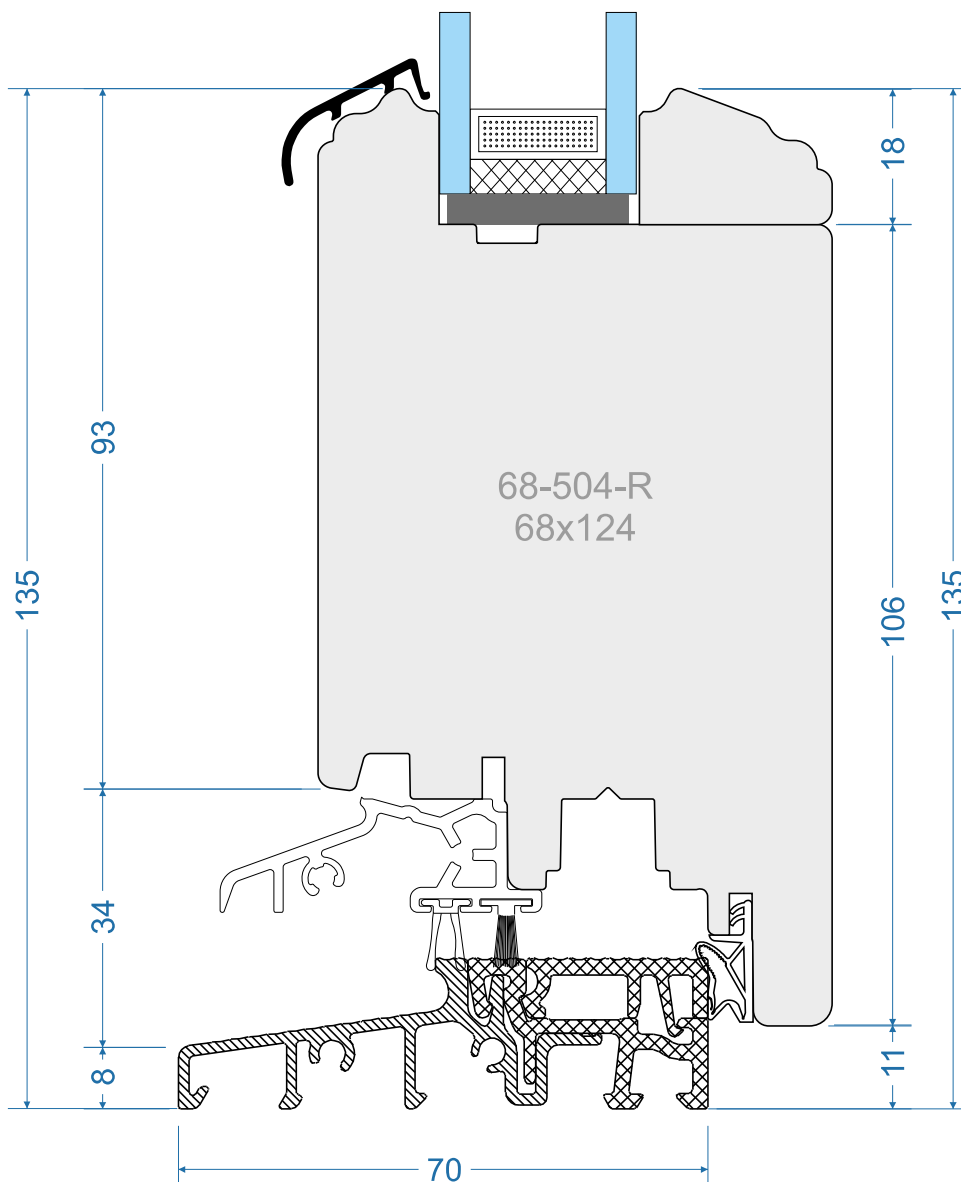

-  Wyrównanie do „Próg aluminiowy + skrzydło 77mm + cokół 66mm + cokół 66mm”
-  Alignment to „Aluminum threshold + sash 77mm + plinth 66mm + plinth 66mm”
-  Alignement sur le „Seuil en aluminium + châssis 77mm + socle 66mm + socle 66mm”
-  Allineamento alla „Soglia in alluminio + anta 77mm + zoccolo 66mm + zoccolo 66mm”
-  Ausrichtung an der „Aluminiumschwelle + Flügel 77mm + Sockel 66mm + Sockel 66mm”

STD-68-R-0030

out

in



-  Próg aluminiowy + skrzydło 124mm
-  Aluminum threshold + sash 124mm
-  Seuil en aluminium + ouvrant 124mm
-  Soglia in alluminio + anta 124mm
-  Aluminiumschwelle + Flügel 124mm

STD-68-R-0031

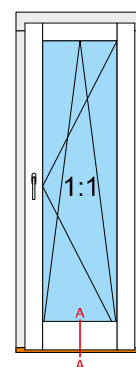

Standard 68mm „S”

Standard 68mm „R”

Classik 68mm „S”

Classik 68mm „R”





Style 01 68mm „S”

Style 01 68mm „R”

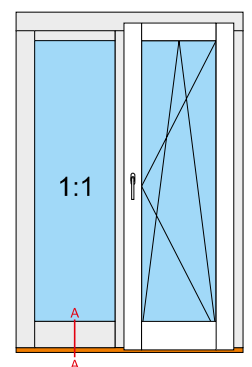
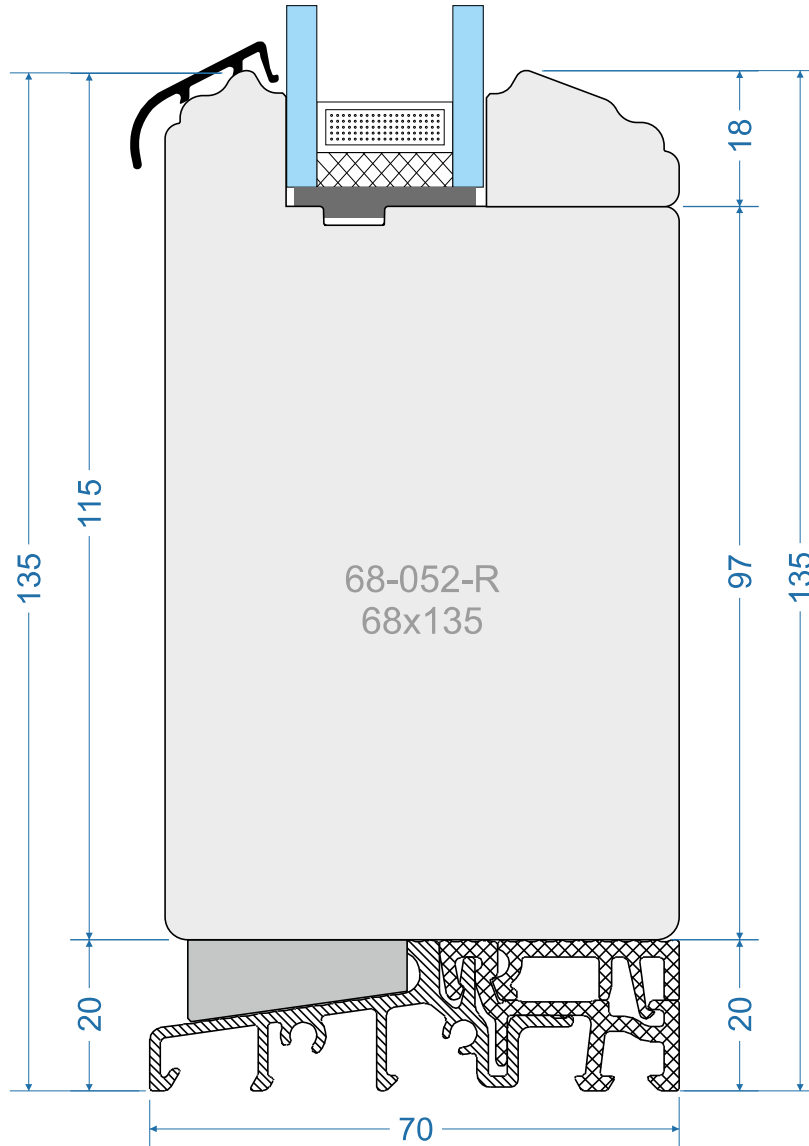
out

in



-  Wyrównanie do „Próg aluminiowy + skrzydło 124mm”
-  Alignment to „Aluminum threshold + sash 124mm”
-  Alignement sur le „Seuil en aluminium + ouvrant 124mm”
-  Allineamento alla „Soglia in alluminio + anta 124mm”
-  Ausrichtung an der „Aluminiumschwelle + Flügel 124mm”





STD-68-R-0032

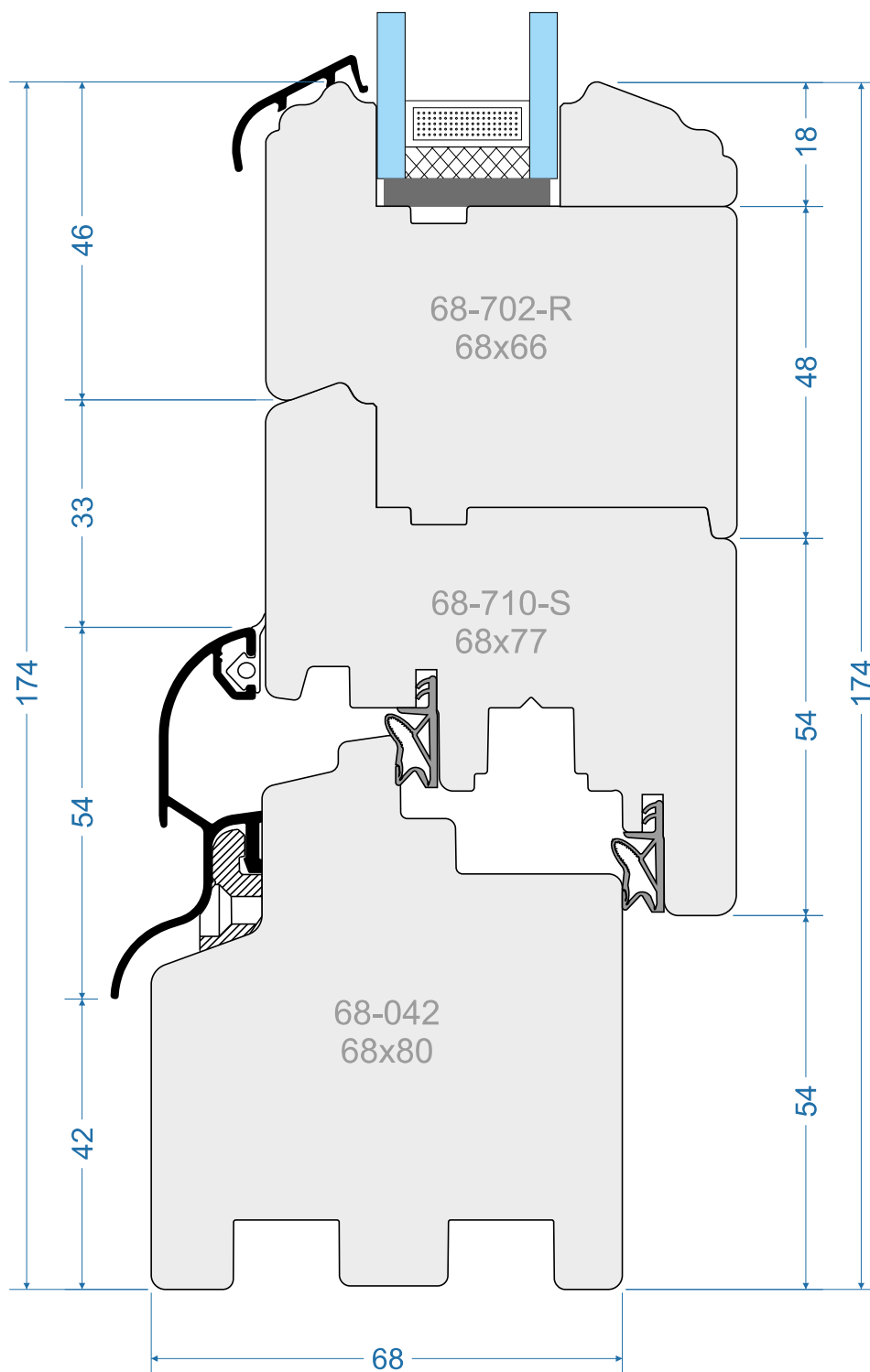

out

in



-  Rama + skrzydło 77mm + cokół 66mm
-  Frame + sash 77mm + plinth 66mm
-  Cadre + châssis 77mm + socle 66mm
-  Telaio + anta 77mm + zoccolo 66mm
-  Rahmen + Flügel 77mm + Sockel 66mm

STD-68-R-0033

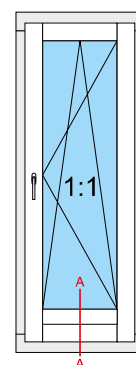

Standard 68mm „S”

Standard 68mm „R”

Classik 68mm „S”

Classik 68mm „R”





Style 01 68mm „S”

Style 01 68mm „R”

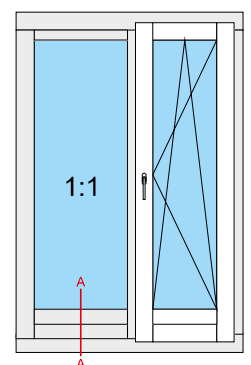
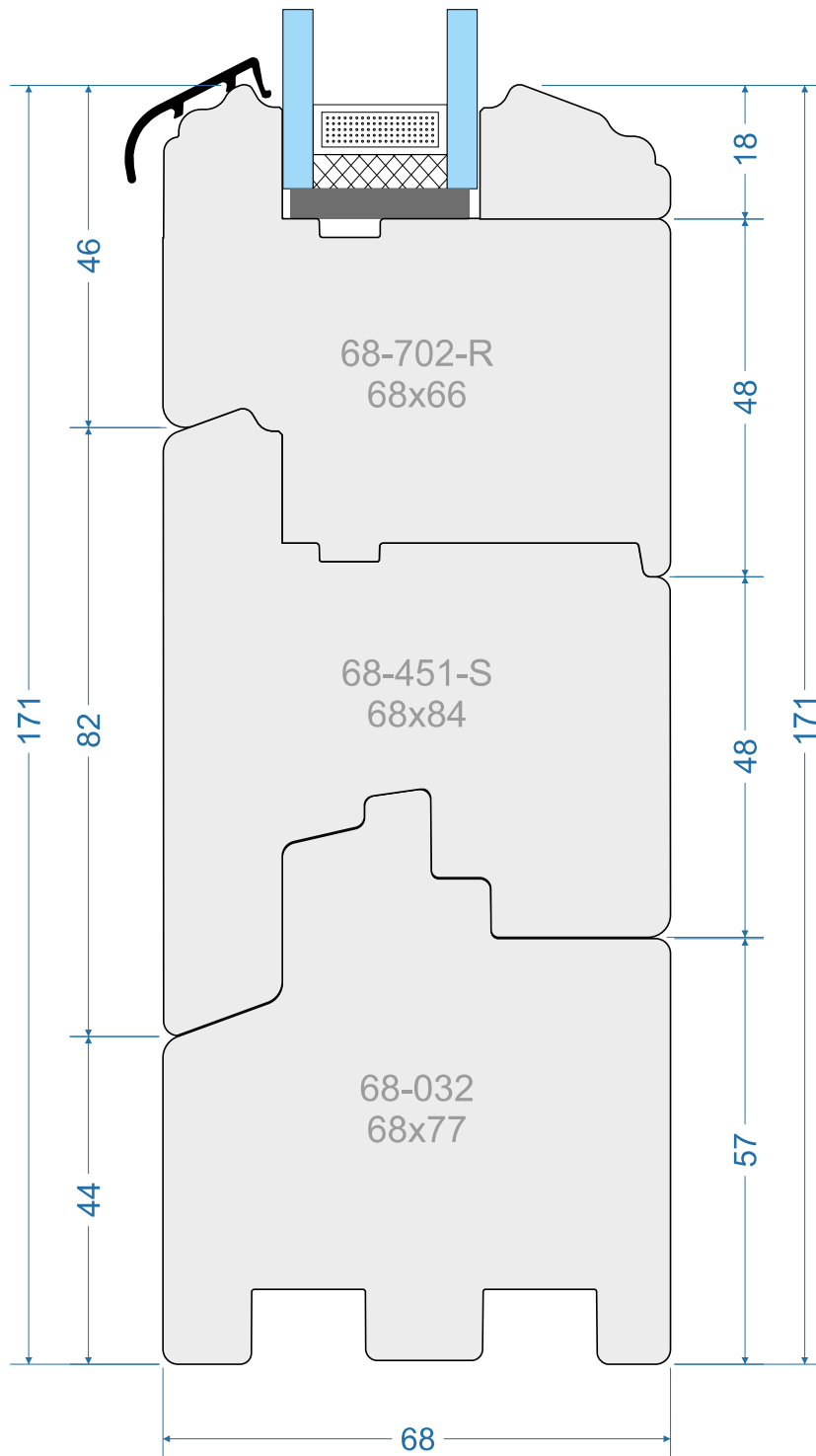
out

in



-  Wyrównanie do „Rama + skrzydło 77mm + cokół 66mm”
-  Alignment to „Frame + sash 77mm + plinth 66mm”
-  Alignement sur le „Cadre + châssis 77mm + socle 66mm”
-  Allineamento alla „Telaio + anta 77mm + zoccolo 66mm”
-  Ausrichtung an der „Rahmen + Flügel 77mm + Sockel 66mm”

out

in

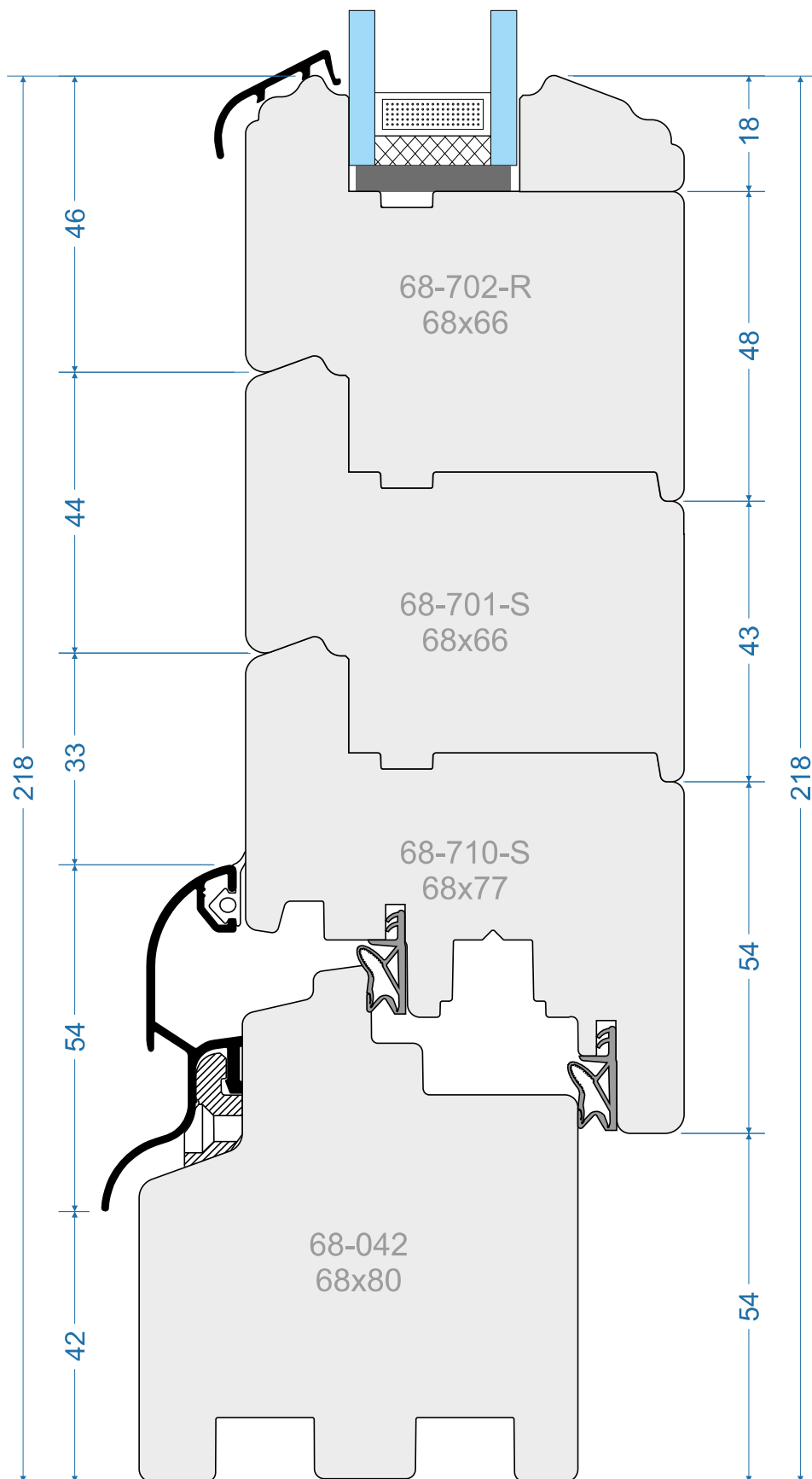

-  Rama + skrzydło 77mm + cokół 66mm + cokół 66mm
-  Frame + sash 77mm + plinth 66mm + plinth 66mm
-  Cadre + châssis 77mm + socle 66mm + socle 66mm
-  Telaio + anta 77mm + zoccolo 66mm + zoccolo 66mm
-  Rahmen + Flügel 77mm + Sockel 66mm + Sockel 66mm

STD-68-R-0035

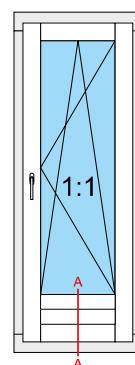

Standard 68mm „S”

Standard 68mm „R”

Classik 68mm „S”

Classik 68mm „R”

Style 01 68mm „S”

Style 01 68mm „R”

Standard 68mm „S”

Standard 68mm „R”

Classik 68mm „S”

Classik 68mm „R”





Style 01 68mm „S”

Style 01 68mm „R”

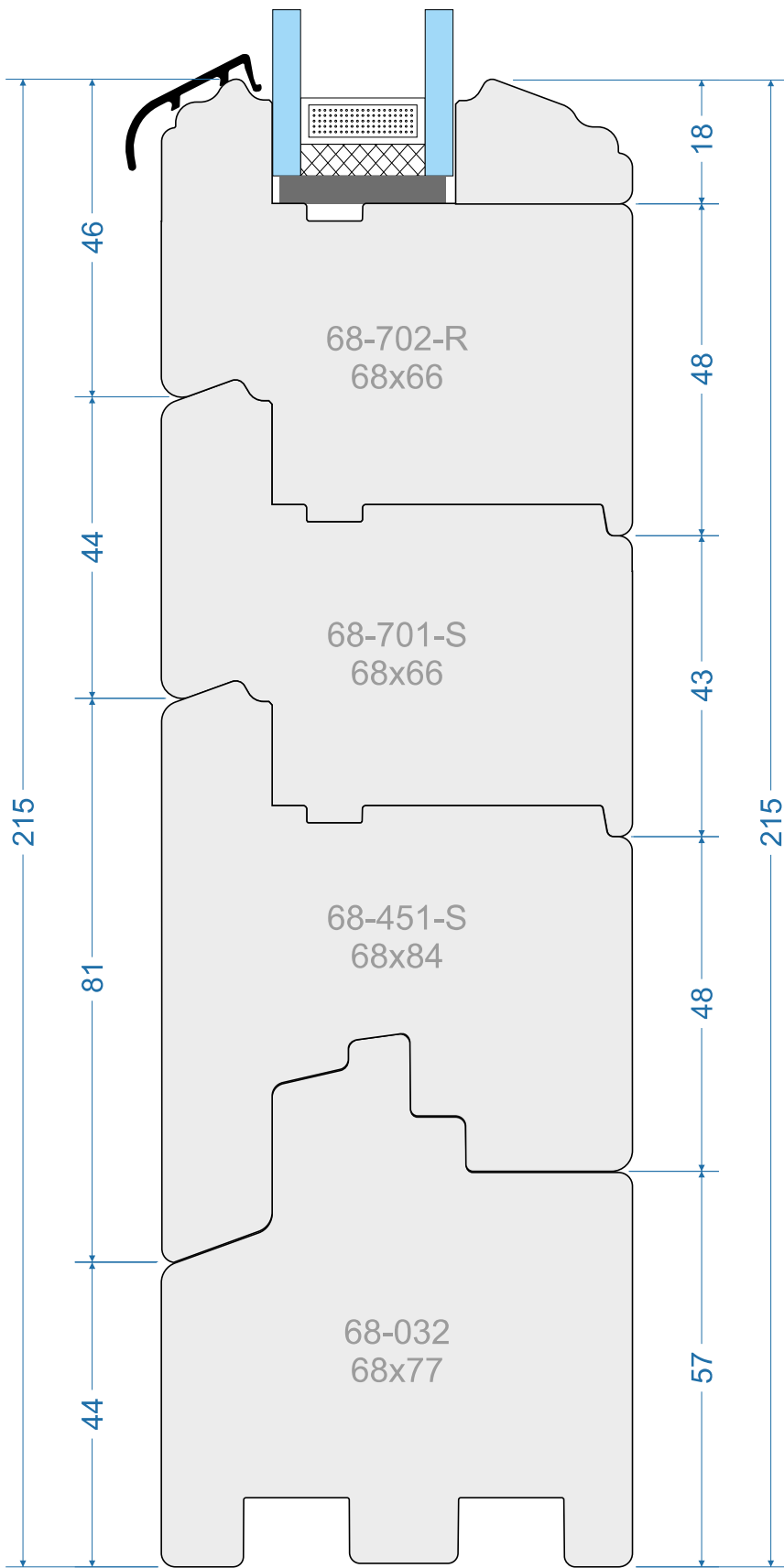
out

in



-  Wyrównanie do „Rama + skrzydło 77mm + cokół 66mm + cokół 66mm”
-  Alignment to „Frame + sash 77mm + plinth 66mm + plinth 66mm”
-  Alignement sur le „Cadre + châssis 77mm + socle 66mm + socle 66mm”
-  Allineamento alla „Telaio + anta 77mm + zoccolo 66mm + zoccolo 66mm”
-  Ausrichtung an der „Rahmen + Flügel 77mm + Sockel 66mm + Sockel 66mm”

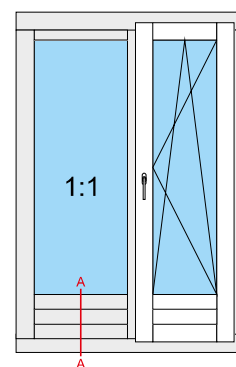

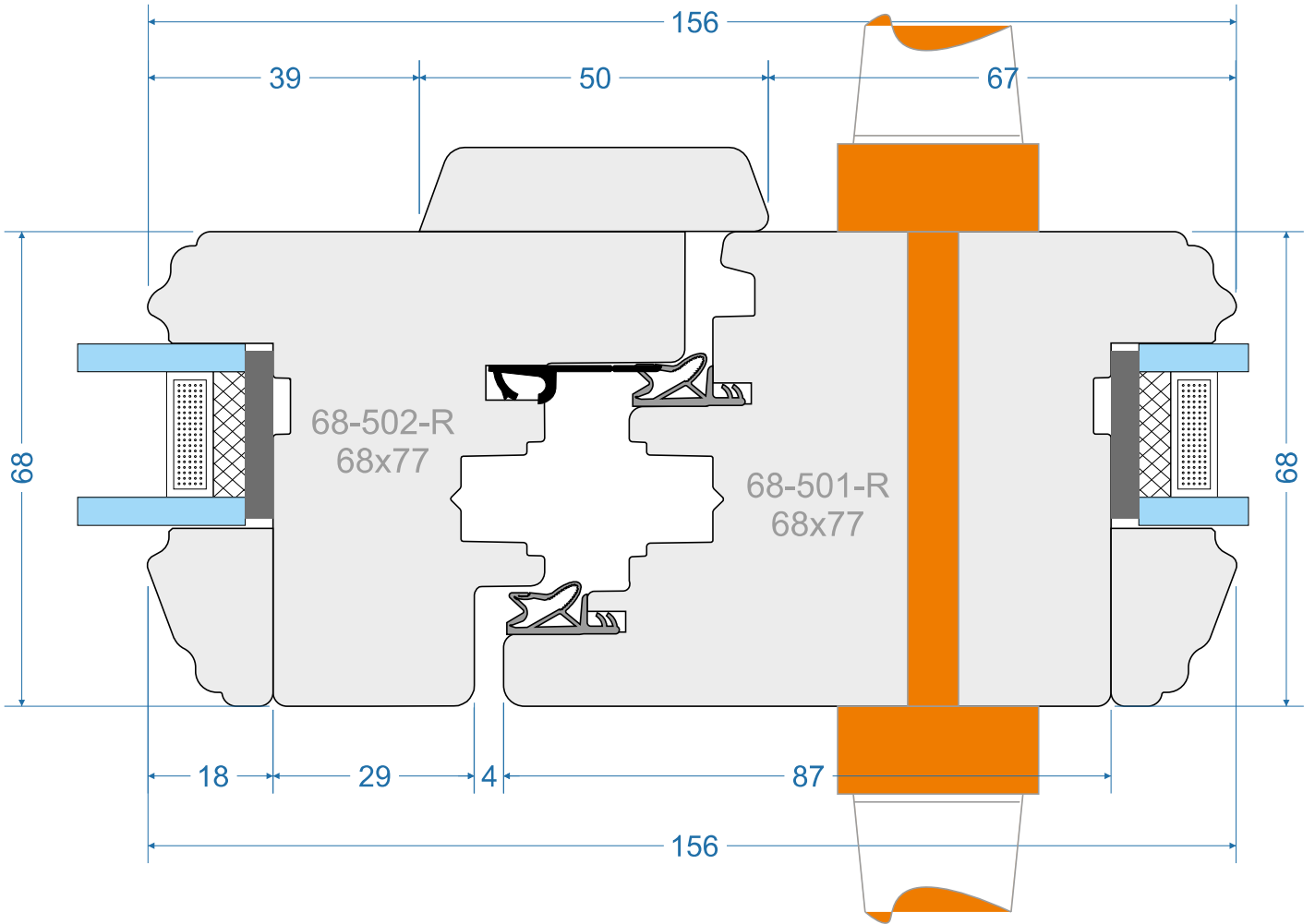

- Standard 68mm „S”
- Standard 68mm „R”
- Classik 68mm „S”
- Classik 68mm „R”
- Style 01 68mm „S”
- Style 01 68mm „R”

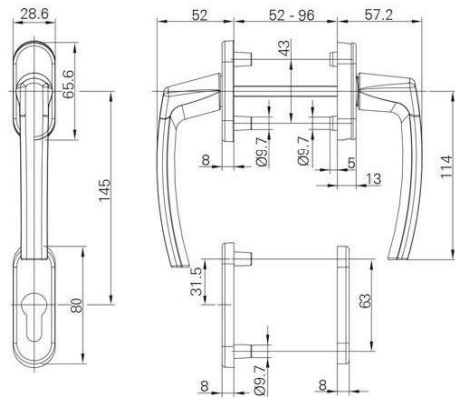

- Dwustronna klamka okienna
- Double side window type handle
- Poignée de fenêtre double face
- Maniglia bifacciale per finestre
- Doppelseitiger Fenster Griff

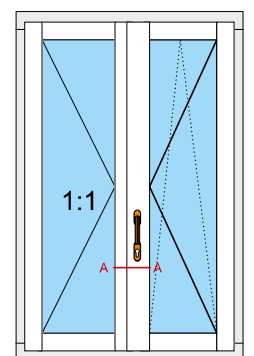

STD-68-R-0037

Standard 68mm „S”

Standard 68mm „R”





Classik 68mm „S”

Classik 68mm „R”

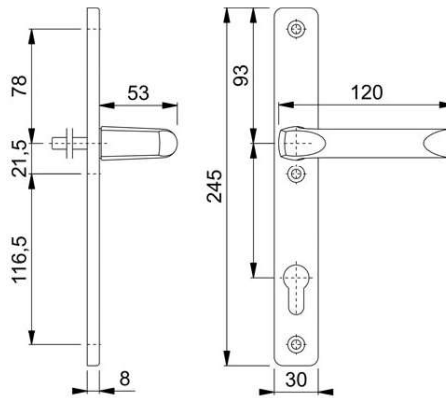
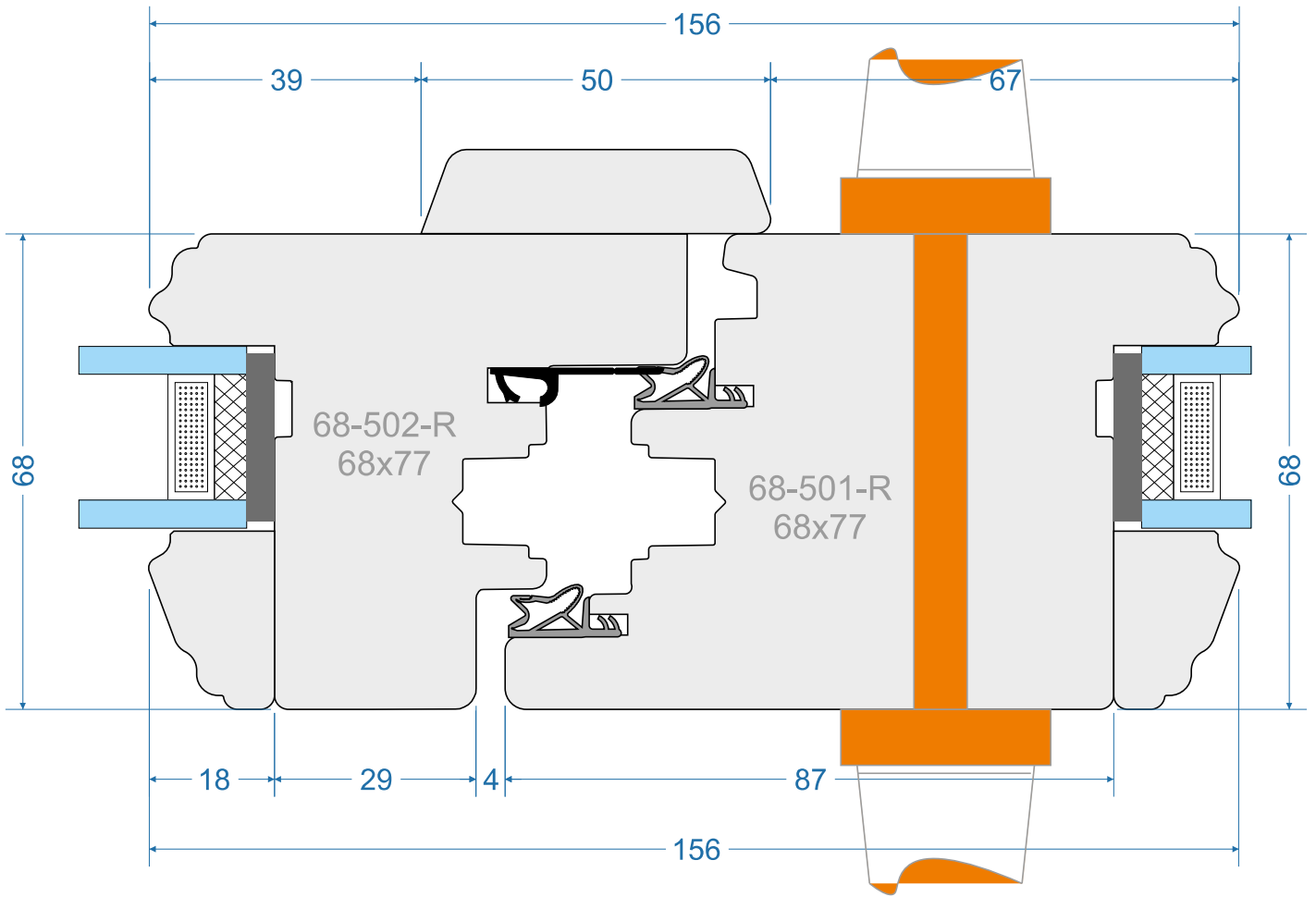
Style 01 68mm „S”





Style 01 68mm „R”

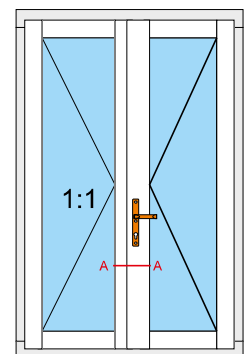

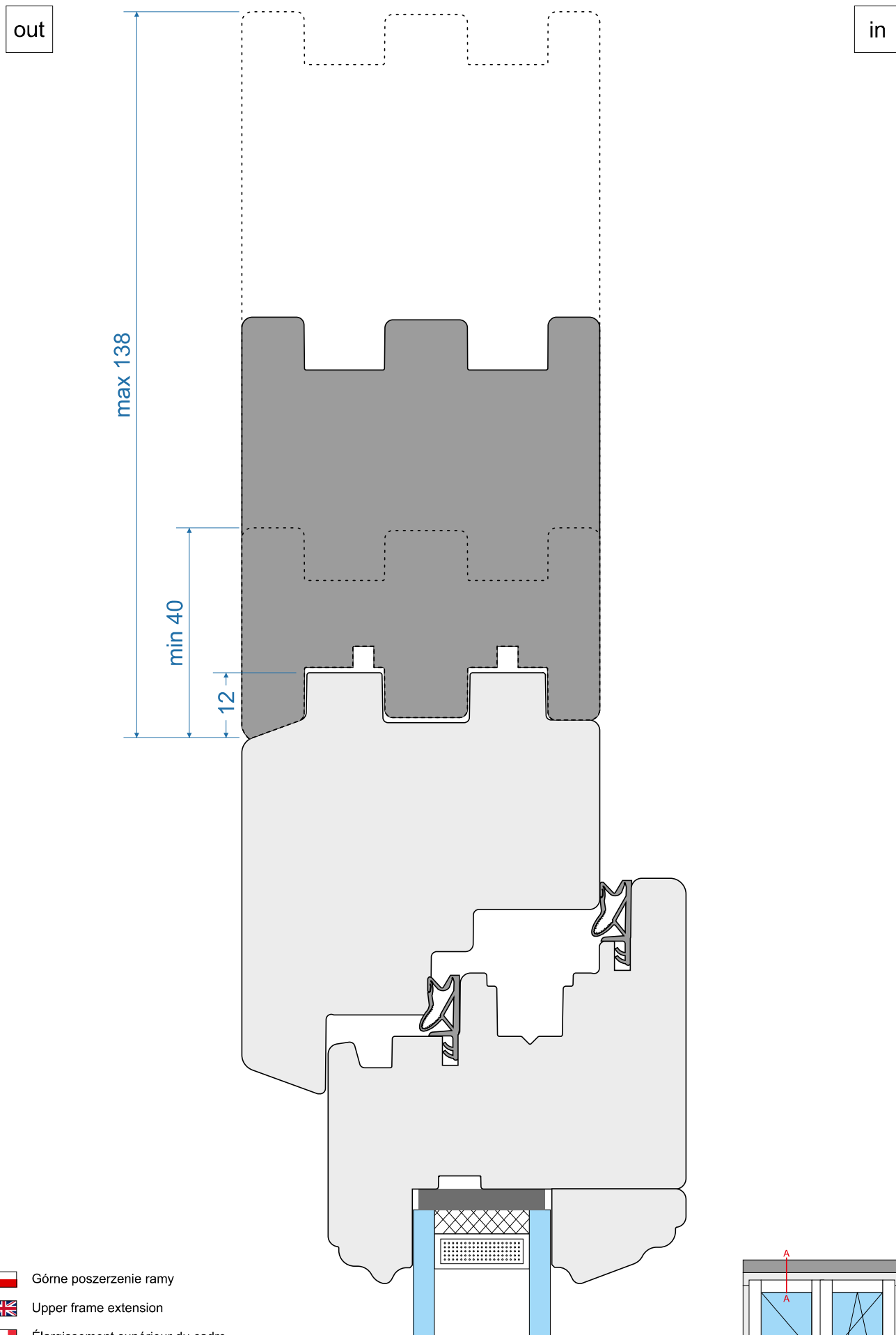
-  Dwustronna klamka drzwiowa
-  Double side door type handle
-  Poignée de Porte Fenêtre double face
-  Maniglia bifacciale per porte finestre
-  Doppelseitiger Tür Griff





-  Górne poszerzenie ramy
-  Upper frame extension
-  Élargissement supérieur du cadre
-  Estensione del telaio superiore
-  Obere Rahmenverbreiterung

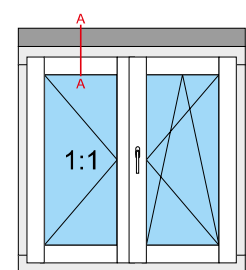

STD-68-R-0039

Standard 68mm „S”
Standard 68mm „R”
Classik 68mm „S”
Classik 68mm „R”
Style 01 68mm „S”
Style 01 68mm „R”

out

Standard 68mm „S”

Standard 68mm „R”

Classik 68mm „S”



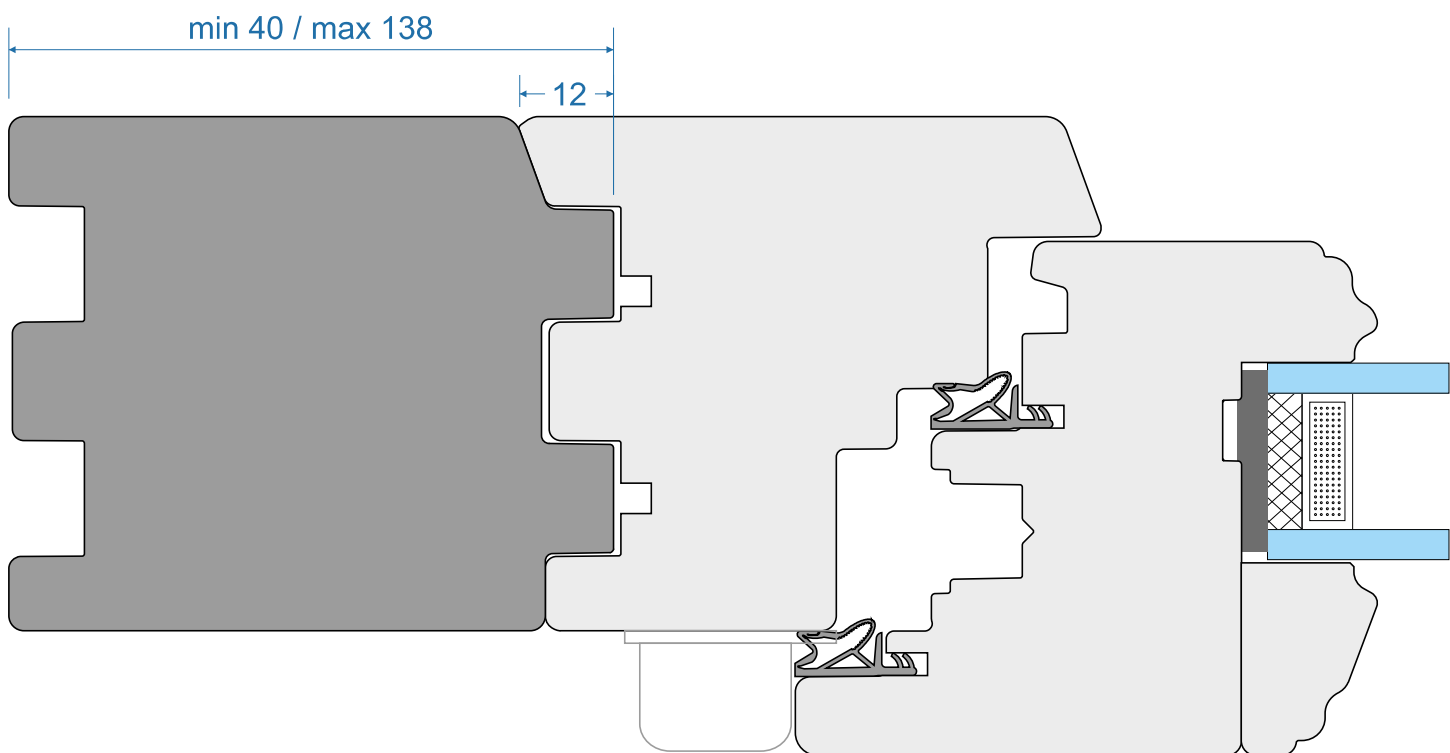

Classik 68mm „R”

Style 01 68mm „S”

Style 01 68mm „R”



in

-  Boczne poszerzenie ramy
-  Side frame extension
-  Élargissement latéral du cadre
-  Estensione del telaio laterale
-  Seitliche Rahmenverbreitung

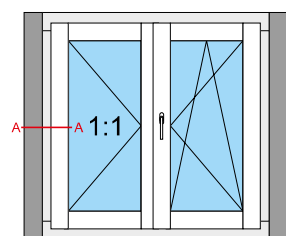





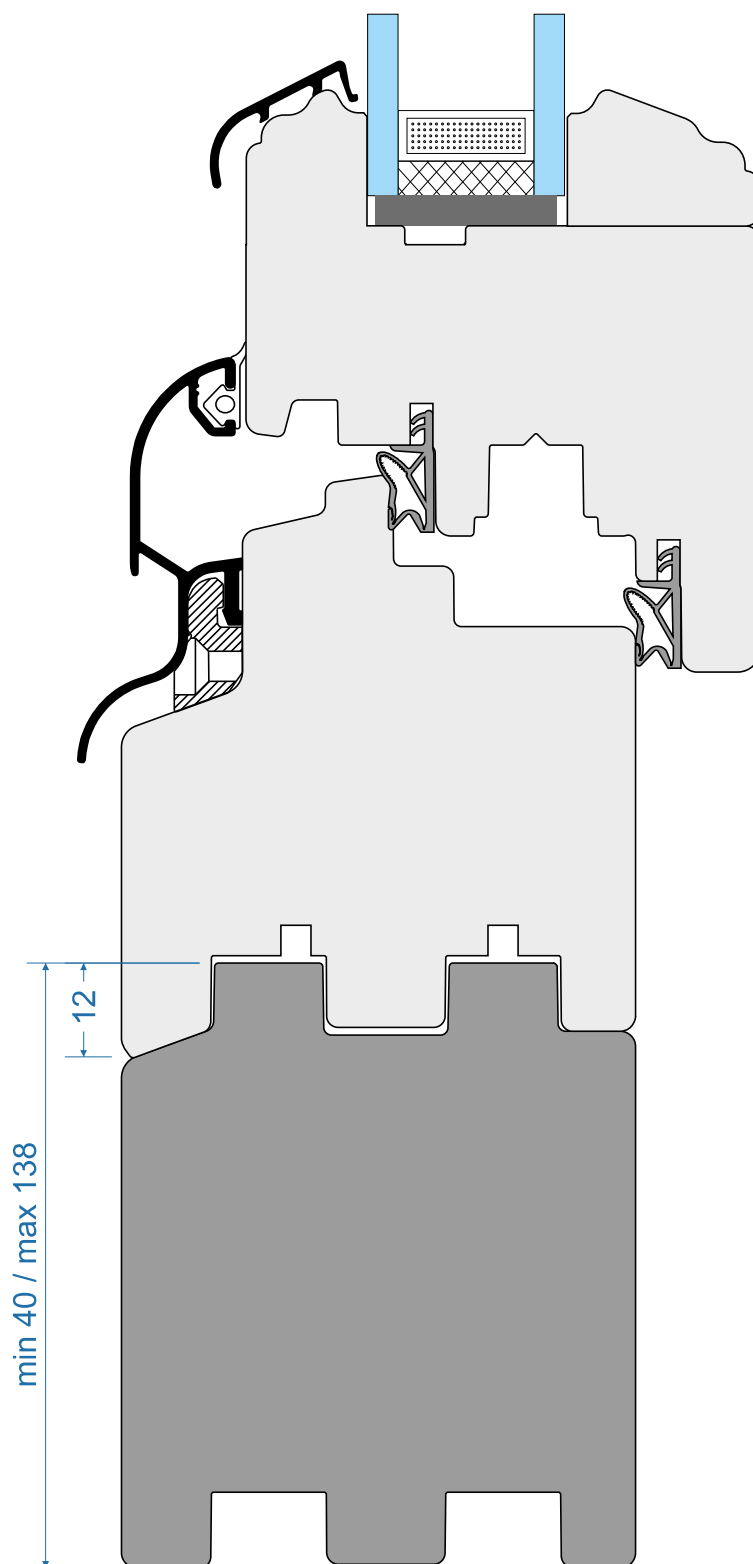

out

in



-  Dolne poszerzenie ramy
-  Lower frame extension
-  Élargissement inférieure du cadre
-  Estensione del telaio inferiore
-  Untere Rahmenverbreitung

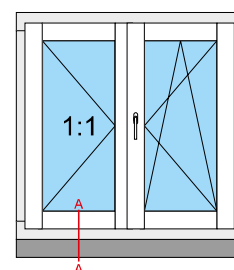

STD-68-R-0041

Standard 68mm „S”

Standard 68mm „R”

Classik 68mm „S”

Classik 68mm „R”

Style 01 68mm „S”

Style 01 68mm „R”

Standard 68mm „S”

Standard 68mm „R”

Classik 68mm „S”

Classik 68mm „R”





Style 01 68mm „S”

Style 01 68mm „R”

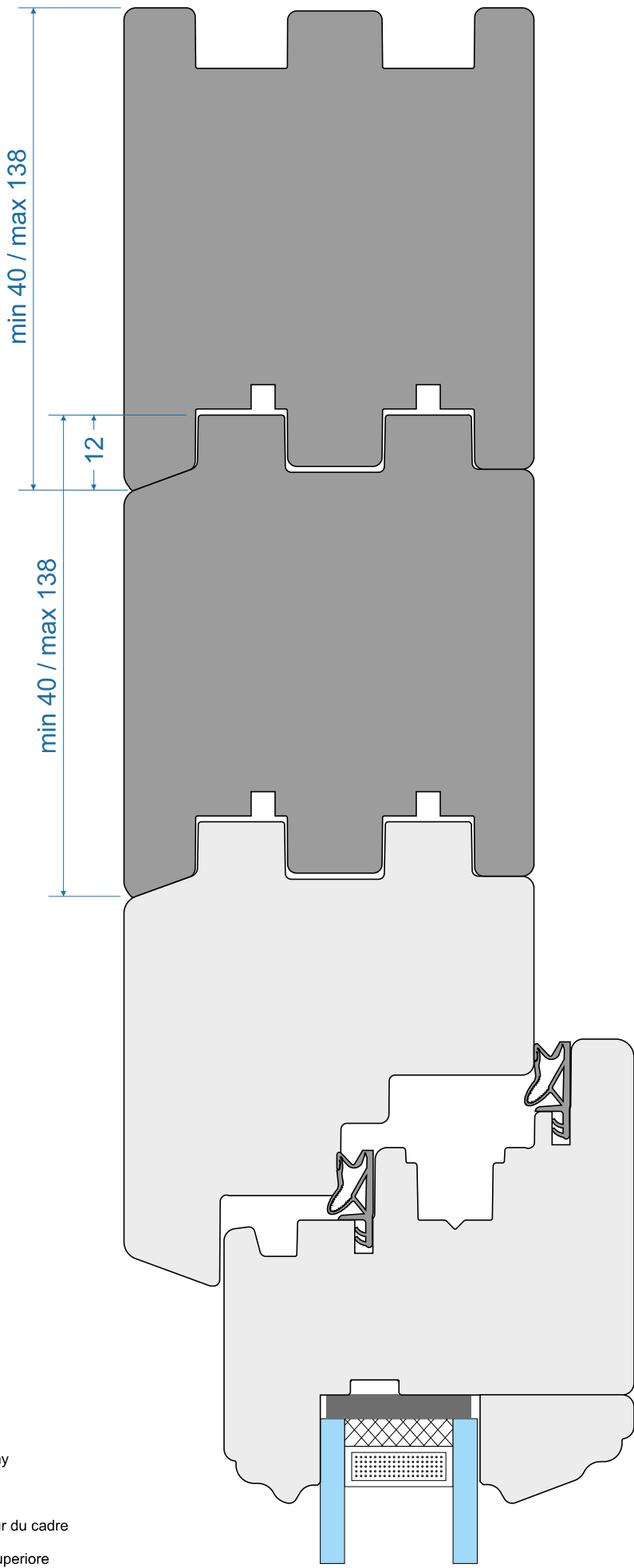
out

in



-  Górne poszerzenie ramy
-  Upper frame extension
-  Élargissement supérieur du cadre
-  Estensione del telaio superiore
-  Obere Rahmenverbreitung

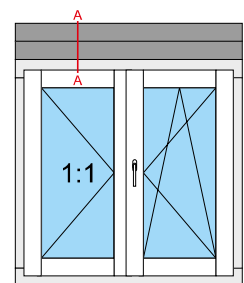



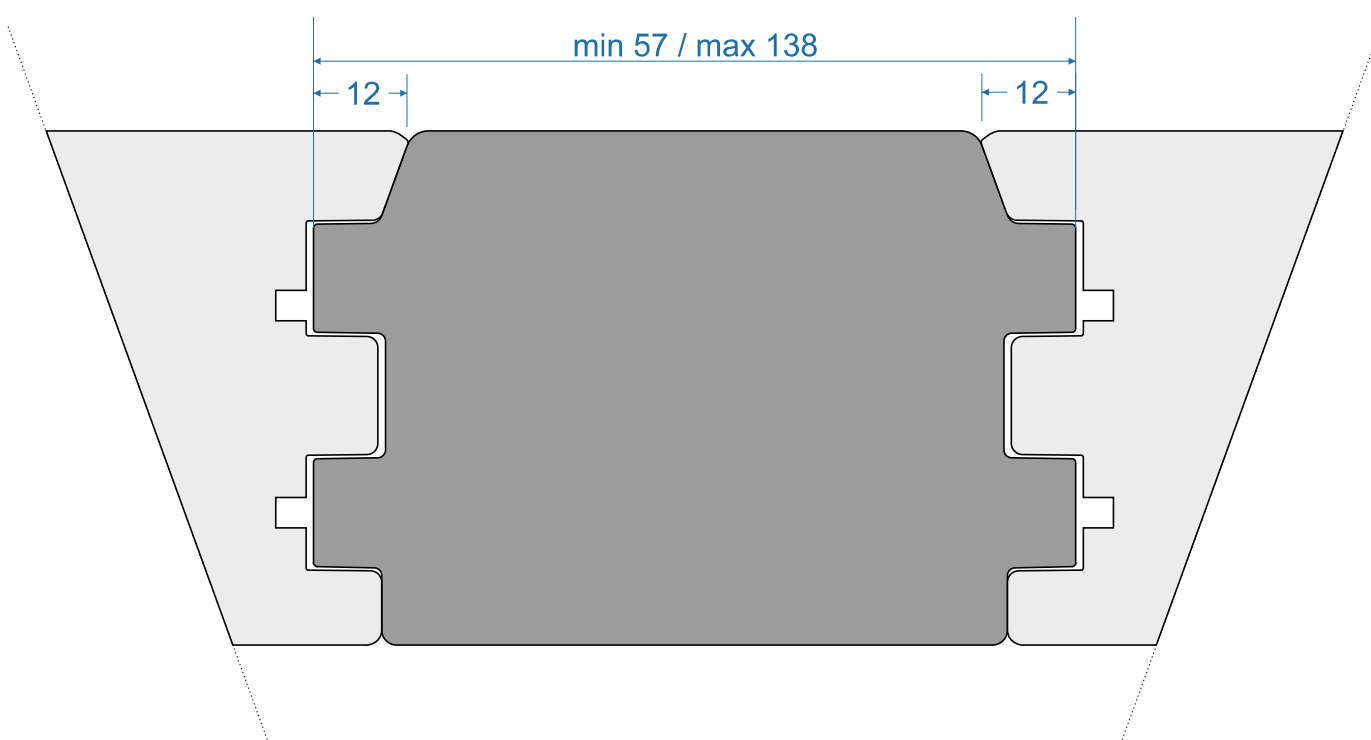

STD-68-R-0042

out

in



-  Środkowe poszerzenie ramy
-  Middle frame extension
-  Montant d'assemblage
-  Montante di accoppiamento
-  Zentral Rahmenverbreiterung

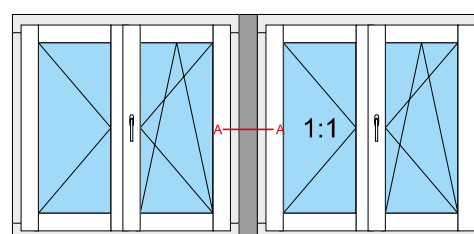

STD-68-R-0043

Standard 68mm „S”

Standard 68mm „R”

Classik 68mm „S”

Classik 68mm „R”

Style 01 68mm „S”

Style 01 68mm „R”

out

Standard 68mm „S”

Standard 68mm „R”

Classik 68mm „S”



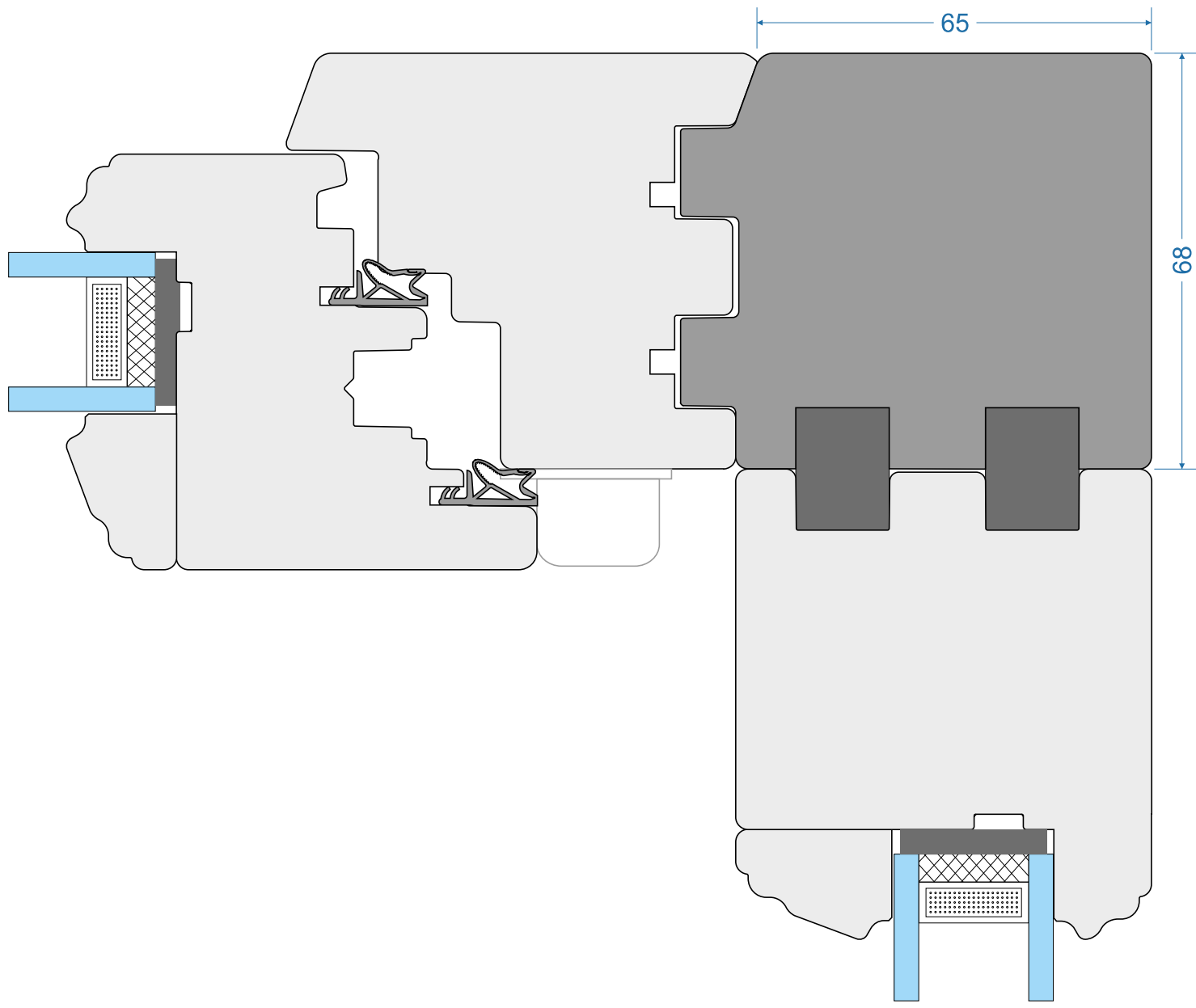

Classik 68mm „R”

Style 01 68mm „S”

Style 01 68mm „R”



in

-  Łącznik 90 stopni
-  90 degree corner connecting post
-  Montant d'assemblage à 90 degrés
-  Montante di accoppiamento 90 gradi
-  90-Grad-Eckpfosten

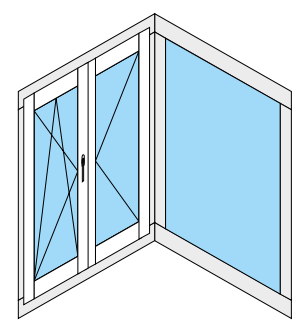

out

in

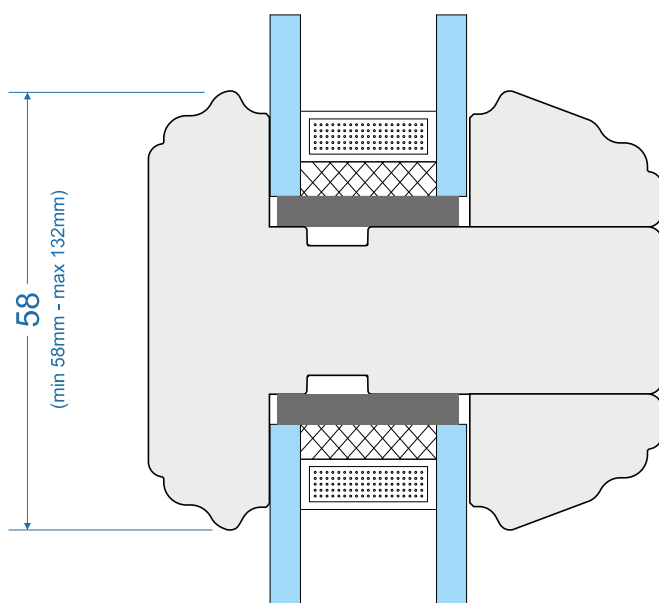

-  Szpros konstrukcyjny
-  Construction type muntin
-  De vrais crossillon
-  Traverso
-  Glasteilende Sprosse

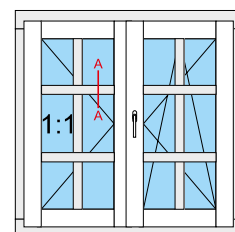

STD-68-R-0045

Standard 68mm „S”

Standard 68mm „R”

Classik 68mm „S”

Classik 68mm „R”

Style 01 68mm „S”

Style 01 68mm „R”

out

in

W-01

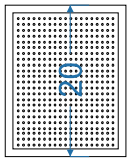
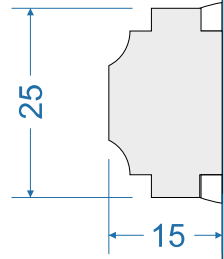

W-02

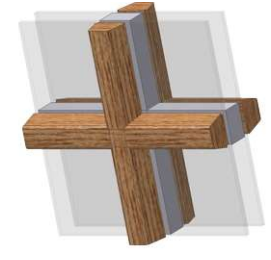
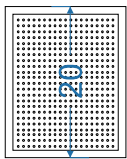
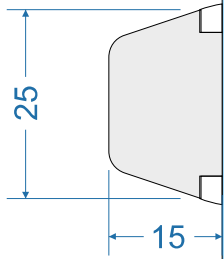

W-03

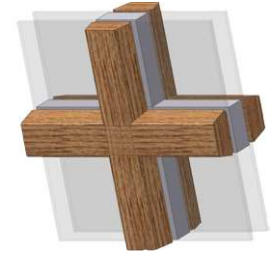
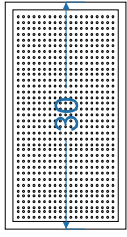
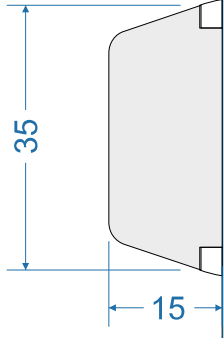



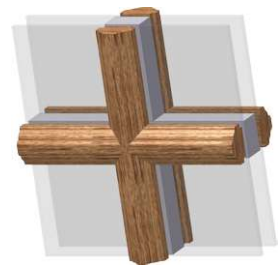
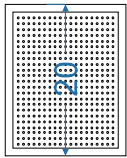
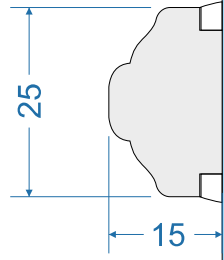

W-04

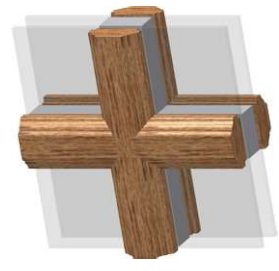
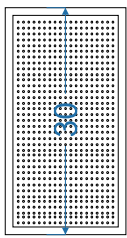
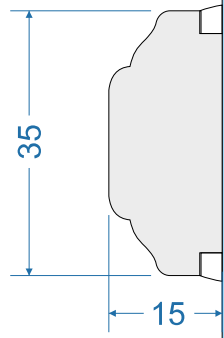

W-05



-  Szpros wideński (Duplex)
-  Vienna muntin (Duplex)
-  Petits bois Viennoise (Duplex)
-  Traverse incollate Viennese (Duplex)
-  Wiener Sprosse (Duplex)

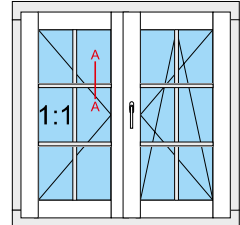

out

in

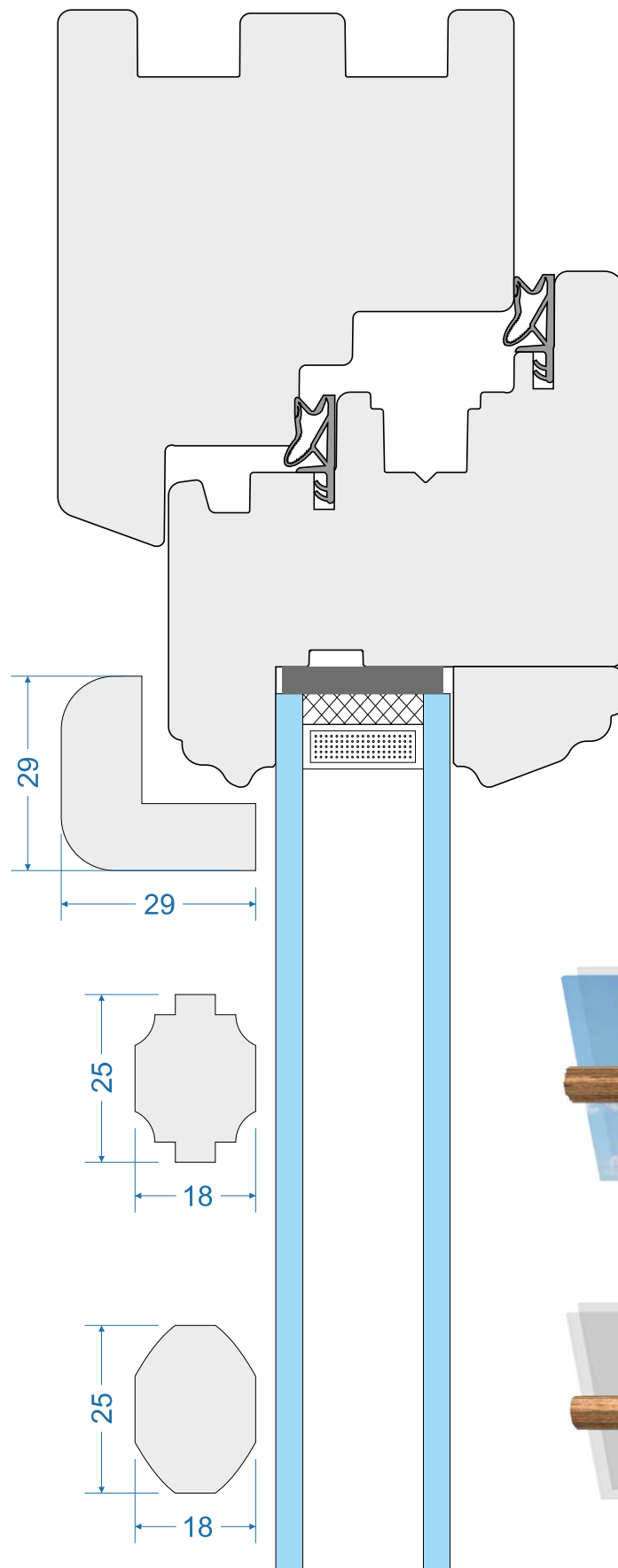

P-01

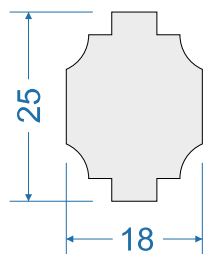

P-02

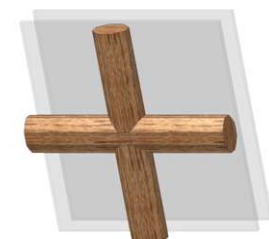
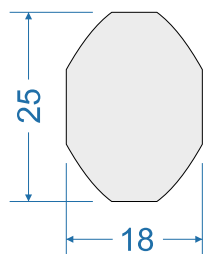

-  Szpros otwierany
-  Openable muntin
-  Croisillon ouvrable
-  Montatura apribile
-  Aufklappbare Sprossen

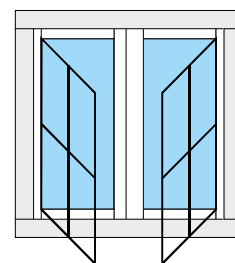

STD-68-R-0047

Standard 68mm „S”

Standard 68mm „R”

Classik 68mm „S”

Classik 68mm „R”

Style 01 68mm „S”

Style 01 68mm „R”